

**POWER TOOL ACCESSORIES CATALOGUE**



**FULL**  
*of* **POWER**



**BAHCO**

VERSION 1.0

1862

# **FULL OF PERFORMANCE**



1969



**In 1862, the Swede Göran Fredrik Göransson founded the companies Högbo Stål and Jernwerks AB for the purpose of producing high-quality steel. These companies formed the basis of Bahco and made us a leading global manufacturer of ergonomic tools.**

By launching the first ever Bi-Metal Hand Hacksaw blade in 1969, we started a new era in cutting performance. Customers started to recognise us by the sublime quality and we became an inspiration for others.

The Bi-Metal blade set the tone for our entire range of cutting tools and also has a strong part to play in the Power Tool Accessories range, with Holesaws, Sabre Saws, Jigsaws and Band Saws – still the most powerful of their kind.

# **FULL OF POWER**

**Our many years of knowledge and experience have led to a full range of Power Tool Accessories. Over 2,000 products and growing**

Thanks to this comprehensive range, professionals now only need Bahco. One strong brand on which they can build. A full range of premium-quality Power Tool Accessories to meet every need.



# A FULL RANGE OF POWERFUL PRODUCTS





# **FULL SUPPORT**

**You can quickly find the right product for your application thanks to the information on the product and the new packaging.**

The improved packaging line contains powerful symbols that clearly indicate the applications for which the product is designed.

On every product, Bahco has printed or engraved clear information that will save precious time for you. This may be the application or material to be cut, or the size and tothing for example. So whatever the job, you will find the right product fast!

## WOOD



COARSE WOOD



WOOD



WOOD  
BOARDS

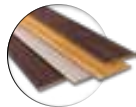

LAMINATED  
WOOD

## METAL



ALUMINIUM



METAL STEEL



THICK METAL



TOOL STEEL

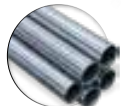

STAINLESS  
STEEL



METAL SHEET



MILD STEEL



COPPER



BRASS



CAST IRON

## STONE



BRICK



LECA BRICK

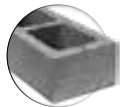

LIGHT BRICK

## SPECIAL



WOOD & NAILS



PALLET REPAIR



PLASTER  
BOARD



WALL (MC)



STEEL &  
CONCRETE

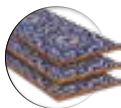

TILES

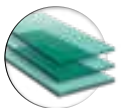

GLASS



DEMOLITION



FIBREGLASS



PLASTIC



JUNKYARD



FIRE & RESCUE



MEAT & ICE





# PRODUCT INDEX



## HOLESAWS

10

## SABRE SAW BLADES

30

## JIGSAW BLADES

48

## CIRCULAR SAW BLADES

58

MULTI-CONSTRUCTION SUPERIOR HOLESAWS

BI-METAL SANDFLEX HOLESAWS

CARBIDE TIPPED HOLESAWS

HOLESAW ACCESSORIES

SABRE SAW BLADES FOR METAL

SABRE SAW BLADES FOR WOOD & METAL

SABRE SAW BLADES FOR WOOD

SABRE SAW BLADES FOR SPECIAL APPLICATIONS

SABRE SAW BLADES SETS

JIGSAW BLADES FOR METAL

JIGSAW BLADES FOR WOOD & METAL

JIGSAW BLADES FOR WOOD

CIRCULAR SAW BLADES FOR WOOD

CIRCULAR SAW BLADES FOR ALUMINIUM AND PLASTIC





**PORTABLE BAND  
SAW BLADES 68**

**ROTARY  
BURRS 74**

**DRILL  
BITS 98**

**SCREWDRIVER  
BITS 122**

*EASY-CUT PORTABAND*

*CARBIDE  
ROTARY BURRS*

*CARBIDE ROTARY BURRS  
FOR ALUMINIUM*

*HIGH SPEED STEEL ROTARY BURRS*

*DRILL BITS FOR REINFORCED  
CONCRETE*

*CHISELS FOR REINFORCED  
CONCRETE*

*DRILL BITS FOR WOOD*

*DRILL BITS FOR METAL*

*STEP DRILL BITS*

*DIAMOND SCREWDRIVER BITS*

*TIN TORSION SCREWDRIVER BITS*

*ACR TORSION SCREWDRIVER BITS*

*TORSION SCREWDRIVER BITS*

*EXTRA HARD TORSION  
SCREWDRIVER BITS*

*STAINLESS STEEL TORSION  
SCREWDRIVER BITS*

*ORIGINAL SCREWDRIVER BITS*

*SCREWDRIVER BIT HOLDERS,  
POWER NUT DRIVERS AND  
ADAPTORS*

299

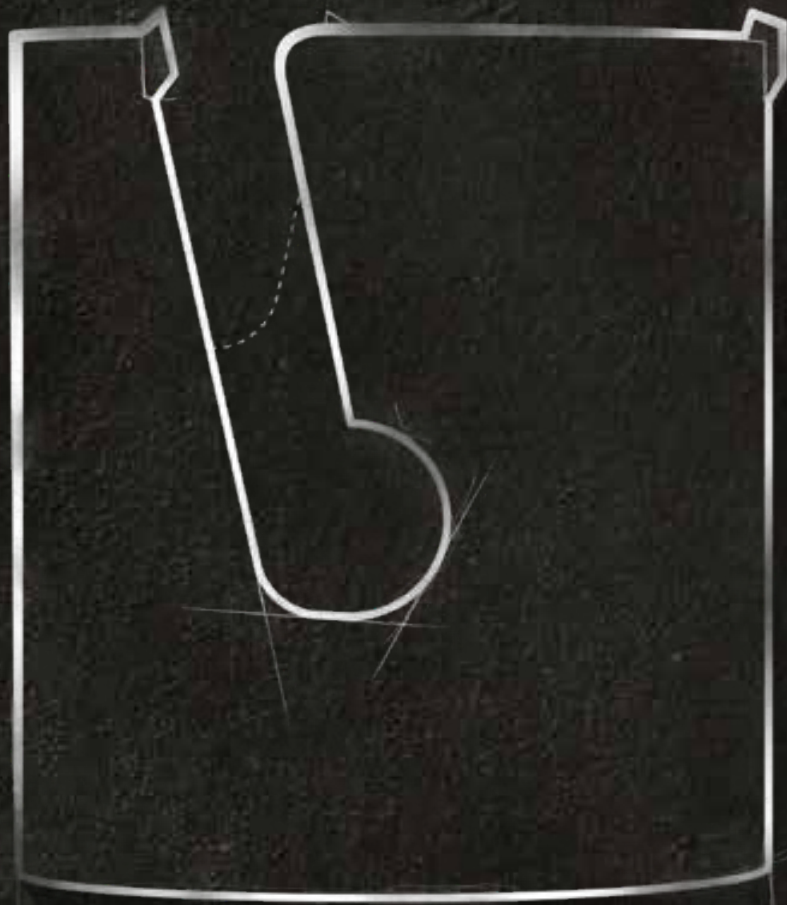
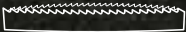
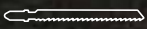
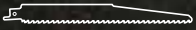



# BAHCO HOLESAWS

## PRODUCT INDEX

<i>MULTI-CONSTRUCTION SUPERIOR HOLESAWS</i>	16
<i>BI-METAL SANDFLEX HOLESAWS</i>	18
<i>CARBIDE TIPPED HOLESAWS</i>	22
<i>QUICK-EJECT ARBOR</i>	25

**299**  
PRODUCTS

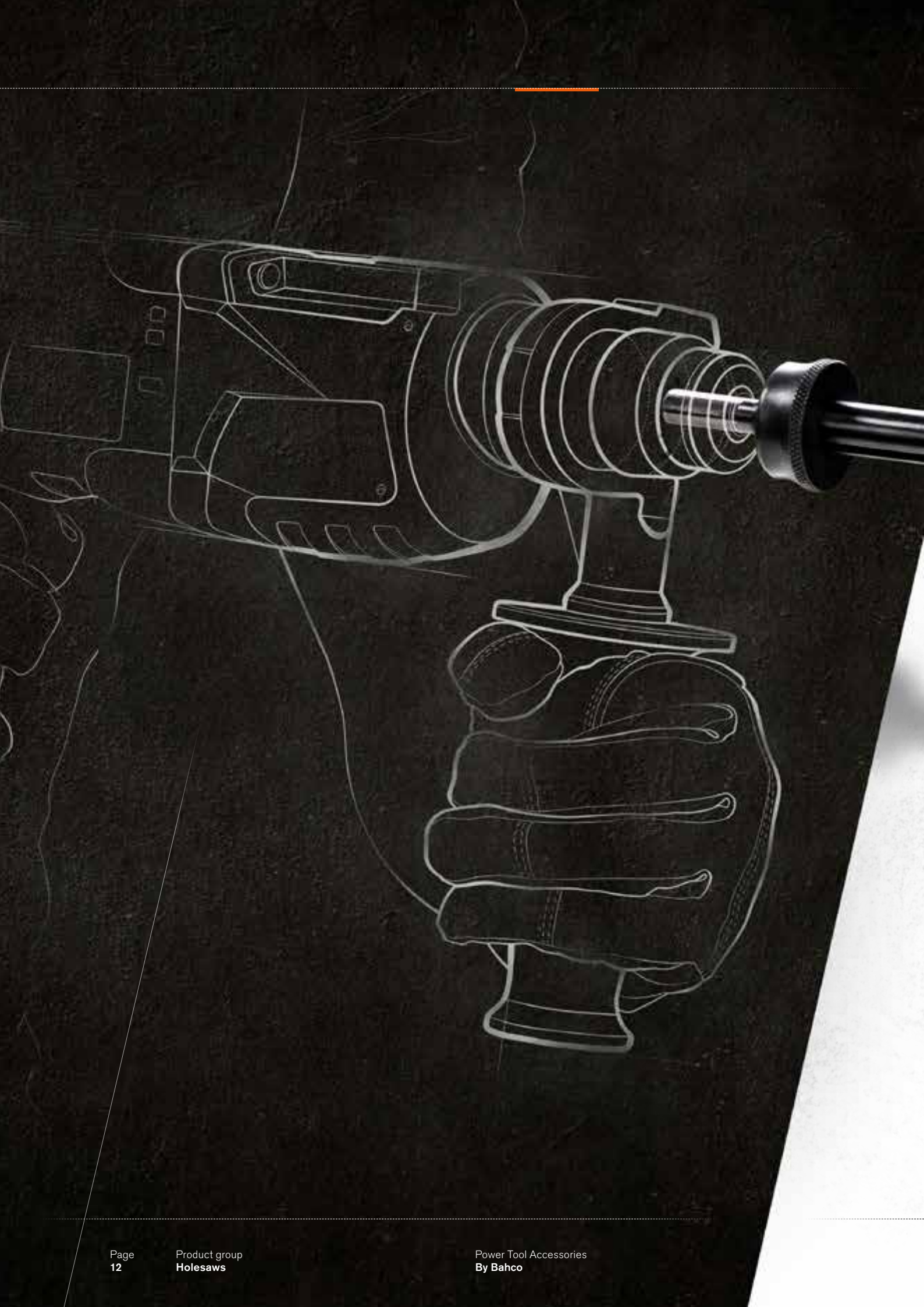

# TIME-**SAVING TOOLS** WITH **CUTTING-EDGE** **PERFORMANCE**

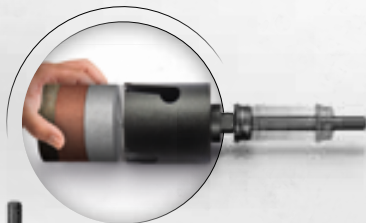

**QUICK-EJECT ARBOR FOR  
FAST AND EASY CORE REMOVAL**

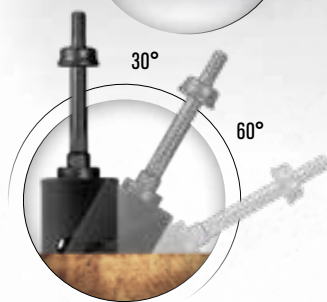

**CUTTING HOLES  
AT AN ANGLE**

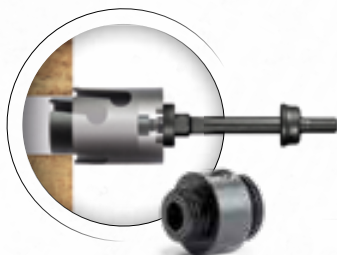

**UPSIZE ADAPTOR FOR  
ENLARGING EXISTING HOLES**

299

# FULL OF POWER

**Bahco Holesaws set the standard in precision, quality, durability and versatility. Whatever the job, you will find the Holesaws and accessories you need.**

Each part of the Holesaw is designed to boost productivity and craftsmanship, from the design of the cutting edges to the technologies used in production. There is consistent quality and total control from making the Bi-Metal all the way to the finished Holesaw. In our own R&D department, we test and develop innovations to ensure that we stay ahead of the market. Our wide range of Holesaws and accessories will meet your needs for almost any material. They are compatible with all machine brands.

## COMPLETE HOLESAW SYSTEM

Looking for maximum performance and flexibility? Bahco's line of arbors, extensions, pilot drills, ejector springs and adaptors are designed as a fully interchangeable system.

## FULL SUPPORT

### CUTTING SPEED RECOMMENDATIONS

To get maximum result out of each Holesaw, we recommend the following cutting speeds (RPM).



FE



18/8



Cast iron



CuZn



Alu



Wood

**14-19 mm:**

580-460

300-240

400-300

790-600

900-690

3000

**20-30 mm:**

435-285

230-145

290-190

580-380

660-425

3000-2400

**32-48 mm:**

275-180

140-90

180-120

360-240

410-270

2400-2100

**51-76 mm:**

170-115

85-55

115-75

230-150

255-170

2000-1500

**79-105 mm:**

110-80

55-40

70-55

140-110

165-120

1500-1000

**108-152 mm:**

80-55

40-25

55-35

110-75

120-75

900-800

**168-210 mm:**

50-40

25-20

35-25

70-55

75-60

700-500

### CARBIDE TIPPED HOLESAW



Fibreglass



Laminate



Brick



Tiles

**14-19 mm:**

2380-1790

1360-1020

1705-1280

680-510

**20-30 mm:**

1700-1130

970-640

1210-810

480-320

**32-48 mm:**

1070-710

610-410

770-510

310-205

**51-76 mm:**

670-450

380-260

480-320

190-130

**79-105 mm:**

430-320

250-185

310-235

125-92

**108-152 mm:**

310-220

180-130

230-160

90-65



# FULL RANGE

299  
PRODUCTS

	<b>MULTI-CONSTRUCTION SUPERIOR HOLESAWS</b>	<b>BI-METAL SANDFLEX HOLESAWS</b>	<b>CARBIDE TIPPED HOLESAW</b>
<b>Range</b>	 19-225 mm	 14-210 mm	 14-152 mm
<b>Application</b>			
<b>Sets</b>	✓	✓	
<b>Quick-Eject Arbors</b>	3834-ARBR-930EL 3834-ARBR-9100EL	3834-ARBR-930ESM 3834-ARBR-9100ESM	3834-ARBR-930ES 3834-ARBR-9100ES
<b>Standard Arbors</b>	3834-ARBR-630   3834-ARBR-730   3834-ARBR-930   3834-ARBR-1130		
<b>Quick Change Arbors</b>	3834-ARBR-9100QC   3834-ARBR-11152QC   3834-ARBR-16152QC		
<b>Power Driver™ Arbors</b>	3834-ARBR-9100   3834-ARBR-11152   3834-ARBR-16152		
<b>Arbors with SDS+ shank</b>	3834-ARBR-SD30   3834-ARBR-SD152QC		
<b>Pilot Drills Quick-Eject Arbors</b>	3834-DRL-EL	3834-DRL-EL	3834-DRL-ES
<b>Pilot Drills Standard Arbors</b>	3834-DRL-L	3834-DRL	3834-DRL-CT
<b>Upsize Adaptor</b>	3834-UPSIZE		
<b>Ejector Spring</b>	3834-ES		
<b>Arbor Adaptor</b>	3834-ADP		
<b>Arbor Extensions</b>	3834-EXT		

**ARBOR SELECTION DEPENDS ON THE SIZE OF THE HOLESAW. LOOK FOR THE OVERVIEW ON PAGE 24**

# MULTI-CONSTRUCTION SUPERIOR HOLESAWS



66 PRODUCTS



**GO STRAIGHT THROUGH  
A WALL IN ONE GO!**

PERMANENT LASER MARKING  
OF THE SIZE IN MILLIMETRES  
AND INCHES



WIDE GULLETS FOR FAST  
AND EFFECTIVE CHIP REMOVAL

SPECIAL COATING MINIMISES  
HEAT AND FRICTION

INSTANT PENETRATION  
THANKS TO PRECISION  
TOOTH GEOMETRY

SIMPLE HOLESAW SELECTION  
THANKS TO THE PRINTED  
MATERIAL INFORMATION

CUTTING DEPTH OF 71MM!

3833

## MULTI-CONSTRUCTION SUPERIOR HOLESAWS



### FEATURES:

- Premium Carbide tipped holesaws with deep gullets for effective chip removal and fast cutting
- Works excellently on wood, wood with nails, bricks, MDF, plaster board, veneer and plastics etc.
- Extra-deep cutting, 71mm when cutting through a wall
- Permanent laser marking to ensure that you always find the size you need







- Exceptional to use in combination with our Quick-Eject arbors (3834-ARBR-930EL/-9100EL)
- Max. hole size = nominal holesaw size +1.5 mm./- 0.0
- Holesaws up to 159mm are packaged in retail packing with tooth protectors
- Holesaws above 159mm are packaged in cardboard boxes







### ASSORTMENT:

3833-19-C	7314150263561	1	1	19	60
3833-20-C	7314150263578	1	1	20	60
3833-22-C	7314150263585	1	1	22	70
3833-25-C	7314150263592	1	1	25	90
3833-27-C	7314150263608	1	1	27	100

3833-29-C	7314150263615	1	1	29	110
3833-30-C	7314150263622	1	1	30	120
3833-32-C	7314150263639	1	1	32	120
3833-35-C	7314150263646	1	1	35	140
3833-38-C	7314150263653	1	1	38	160



					
3833-40-C	7314150263660	1	1	40	140
3833-41-C	7314150263677	1	1	41	150
3833-44-C	7314150263684	1	1	44	160
3833-48-C	7314150263691	1	1	48	190
3833-51-C	7314150263707	1	1	51	200
3833-54-C	7314150263714	1	1	54	220
3833-56-C	7314150314676	1	1	56	260
3833-57-C	7314150263721	1	1	57	240
3833-60-C	7314150263738	1	1	60	260
3833-62-C	7314150314683	1	1	62	280
3833-64-C	7314150263745	1	1	64	280
3833-65-C	7314150263752	1	1	65	290
3833-67-C	7314150263769	1	1	67	300
3833-68-C	7314150263776	1	1	68	310
3833-70-C	7314150263783	1	1	70	320
3833-71-C	7314150314690	1	1	71	340
3833-73-C	7314150263790	1	1	73	340
3833-74-C	7314150314706	1	1	74	355
3833-76-C	7314150263806	1	1	76	370
3833-77-C	7314150263813	1	1	77	370
3833-78-C	7314150314713	1	1	78	400
3833-79-C	7314150263820	1	1	79	420

					
3833-83-C	7314150263837	1	1	83	420
3833-86-C	7314150263844	1	1	86	440
3833-89-C	7314150263851	1	1	89	470
3833-92-C	7314150263868	1	1	92	490
3833-95-C	7314150263875	1	1	95	520
3833-98-C	7314150263882	1	1	98	540
3833-102-C	7314150263899	1	1	102	580
3833-105-C	7314150263905	1	1	105	600
3833-108-C	7314150263912	1	1	108	630
3833-109-C	7314150263929	1	1	109	640
3833-111-C	7314150263936	1	1	111	660
3833-114-C	7314150263943	1	1	114	690
3833-121-C	7314150263950	1	1	121	760
3833-127-C	7314150263967	1	1	127	820
3833-133-C	7314150401581	1	1	133	880
3833-140-C	7314150263974	1	1	140	960
3833-152-C	7314150263981	1	1	152	1100
3833-159-C	7314150263998	1	1	159	1180
3833-168	7314150413546	1	1	168	1350
3833-177	7314150413539	1	1	177	1400
3833-210	7314150413522	1	1	210	1870
3833-225	7314150413515	1	1	225	2070

### 3833-SET









## MULTI-CONSTRUCTION SUPERIOR HOLESAW SETS



### FEATURES:

- Superior™ holesaw sets consisting of the most popular sizes for Carpenters, Plumbers and Electricians. Sets also include the Quick-Eject arbor.

### ASSORTMENT:

							
3833-SET-101	7314150315383	19, 22, 29, 35, 44, 51, 64	3834-ARBR-930EL	3834-ARBR-9100EL	3834-DRL-EL	1	2750
3833-SET-201	7314150315406	19, 20, 25, 32, 41, 51, 73, 76, 83, 86	3834-ARBR-930EL	3834-ARBR-9100EL	3834-DRL-EL, 3834-UPSIZE	1	4350
3833-SET-202	7314150315420	19, 20, 25, 32, 41, 51, 57, 60, 73, 83	3834-ARBR-930EL	3834-ARBR-9100EL	3834-DRL-EL, 3834-UPSIZE	1	4100
3833-SET-203	7314150315444	19, 22, 54, 56, 57, 62, 68, 71, 74, 78	3834-ARBR-930EL	3834-ARBR-9100EL	3834-DRL-EL, 3834-UPSIZE	1	4650
3833-SET-204	7314150315468	32, 41, 51, 73, 76, 83, 86	3834-ARBR-930EL	3834-ARBR-9100EL	3834-DRL-EL, 3834-UPSIZE	1	3880
3833-SET-205	7314150330874	22, 35, 44, 51, 67	3834-ARBR-930EL	3834-ARBR-9100EL	3834-DRL-EL, 3834-UPSIZE	1	2810
3833-SET-207	7314150330898	19, 22, 25, 35, 44, 51, 64, 67, 76, 83	3834-ARBR-930EL	3834-ARBR-9100EL	3834-DRL-EL, 3834-UPSIZE	1	3900
3833-SET-208	7314150330904	19, 22, 25, 32, 35, 38, 44, 51, 57, 68, 76	3834-ARBR-930EL	3834-ARBR-9100EL	3834-DRL-EL, 3834-UPSIZE	1	3720
3833-SET-301	7314150315376	25, 32, 35, 51, 54, 76, 92, 114	3834-ARBR-930EL	3834-ARBR-9100EL	3834-DRL-EL, 3834-UPSIZE	1	4380
3833-SET-302	7314150315390	51, 76, 86, 111		3834-ARBR-9100EL	3834-DRL-EL, 3834-UPSIZE	1	3510
3833-SET-303	7314150315413	35, 40, 51, 57, 60, 74, 83, 105		3834-ARBR-9100EL	3834-DRL-EL, 3834-UPSIZE	1	4170
3833-SET-304	7314150315437	19, 25, 32, 35, 51, 54, 76, 92, 114	3834-ARBR-930EL	3834-ARBR-9100EL	3834-DRL-EL, 3834-UPSIZE	1	4200

# BI-METAL SANDFLEX HOLESAWS



136 PRODUCTS



RESEARCHED, DEVELOPED  
AND MANUFACTURED BI-METAL  
HOLESAWS BY BAHCO



SHATTERPROOF BI-METAL BODY  
FOR MORE SAFETY

MADE WITH 8% COBALT TO ENSURE  
A LONGER HOLESAW LIFE

RANGE 14-152 MM HAS  
A 6-DEGREE POSITIVE  
TOOTH ANGLE FOR  
AGGRESSIVE CUTTING

RANGE 168-210 MM HAS  
A 0-DEGREE TOOTH ANGLE  
TO SIMPLIFY CUTTING

SIMPLE HOLESAW SELECTION  
THANKS TO THE PRINTED  
MATERIAL INFORMATION

3830

## BI-METAL SANDFLEX HOLESAWS



### FEATURES:







- Bi-Metal Sandflex® hole saws are specially designed for cutting metal but can be used with most materials, such as wood and plastics
- The hole saw cuts through ferrous metals (steel, stainless steel, cast iron) and non-ferrous metals (aluminium, brass, copper)
- Cutting depth max 38mm (1 1/2")
- Bi-metal construction with 8% cobalt for increased wear resistance
- 4/6 teeth per inch
- Max. hole size = nominal hole saw size +1.5mm./- 0.0
- Extra large sizes: 168 and 210mm with 6 teeth per inch, normal cutting depth 177mm with 4/6 teeth per inch, cutting depth max. 50mm







### ASSORTMENT (-C):

All -C hole saws are packed in a retail package with tooth protector

3830-14-C	7311518228347	1	1	14	30		
3830-16-C	7311518225353	1	1	16	35		
3830-17-C	7311518228354	1	1	17	40		
3830-19-C	7311518225360	1	1	19	43		
3830-20-C	7311518225377	1	1	20	45		







3830-21-C	7311518228361	1	1	21	50		
3830-22-C	7311518225384	1	1	22	52		
3830-24-C	7311518228378	1	1	24	55		
3830-25-C	7311518225391	1	1	25	58		
3830-27-C	7311518225407	1	1	27	60		







					
3830-29-C	7311518225414	1	1	29	65
3830-30-C	7311518225421	1	1	30	65
3830-32-C	7311518225438	1	1	32	70
3830-33-C	7311518228385	1	1	33	75
3830-35-C	7311518225445	1	1	35	75
3830-37-C	7311518228392	1	1	37	80
3830-38-C	7311518225452	1	1	38	85
3830-40-C	7311518228408	1	1	40	90
3830-41-C	7311518225469	1	1	41	93
3830-43-C	7311518228415	1	1	43	100
3830-44-C	7311518225476	1	1	44	100
3830-46-C	7311518228422	1	1	46	115
3830-48-C	7311518225483	1	1	48	120
3830-50-C	7311518260873	1	1	50	130
3830-51-C	7311518225490	1	1	51	135
3830-52-C	7311518228439	1	1	52	140
3830-54-C	7311518225506	1	1	54	150
3830-55-C	7311518270919	1	1	55	155
3830-56-C	7311518228446	1	1	56	160
3830-57-C	7311518225513	1	1	57	165
3830-59-C	7311518228453	1	1	59	170
3830-60-C	7311518225520	1	1	60	177
3830-64-C	7311518225537	1	1	64	200
3830-65-C	7311518228460	1	1	65	205

					
3830-67-C	7311518225544	1	1	67	215
3830-68-C	7311518228477	1	1	68	220
3830-70-C	7311518225551	1	1	70	230
3830-73-C	7311518228484	1	1	73	245
3830-76-C	7311518225568	1	1	76	260
3830-79-C	7311518228491	1	1	79	270
3830-83-C	7311518225575	1	1	83	305
3830-86-C	7311518228507	1	1	86	325
3830-89-C	7311518225582	1	1	89	345
3830-92-C	7311518225599	1	1	92	355
3830-95-C	7311518225605	1	1	95	385
3830-98-C	7311518228514	1	1	98	400
3830-102-C	7311518225612	1	1	102	425
3830-105-C	7311518225629	1	1	105	445
3830-108-C	7311518228521	1	1	108	475
3830-111-C	7311518228538	1	1	111	500
3830-114-C	7311518225636	1	1	114	540
3830-121-C	7311518225643	1	1	121	590
3830-127-C	7311518225650	1	1	127	645
3830-133-C	7311518228545	1	1	133	720
3830-140-C	7311518228552	1	1	140	770
3830-146-C	7311518228569	1	1	146	815
3830-152-C	7311518225667	1	1	152	885

### ASSORTMENT (-VIP):

All -VIP holesaws are packed in a cardboard box with an instruction leaflet enclosed









					
3830-14-VIP	7311518041618	1	6	14	30
3830-16-VIP	7311518041625	1	6	16	35
3830-17-VIP	7311518041632	1	6	17	40
3830-19-VIP	7311518041649	1	6	19	43
3830-20-VIP	7311518041656	1	6	20	45
3830-21-VIP	7311518041663	1	6	21	50
3830-22-VIP	7311518041670	1	6	22	52
3830-24-VIP	7311518041687	1	6	24	55
3830-25-VIP	7311518041694	1	6	25	58
3830-27-VIP	7311518041700	1	6	27	60
3830-29-VIP	7311518041717	1	6	29	65
3830-30-VIP	7311518041724	1	6	30	65
3830-32-VIP	7311518041731	1	6	32	70
3830-33-VIP	7311518041748	1	6	33	75
3830-35-VIP	7311518041755	1	6	35	75
3830-37-VIP	7311518041762	1	6	37	80
3830-38-VIP	7311518041779	1	6	38	85
3830-40-VIP	7311518041786	1	6	40	90
3830-41-VIP	7311518041793	1	6	41	93
3830-43-VIP	7311518041809	1	6	43	100
3830-44-VIP	7311518041816	1	6	44	100
3830-46-VIP	7311518041823	1	6	46	115
3830-48-VIP	7311518041830	1	6	48	120
3830-50-VIP	7311518260866	1	6	50	130
3830-51-VIP	7311518041847	1	6	51	135
3830-52-VIP	7311518041854	1	4	52	140
3830-54-VIP	7311518041861	1	4	54	150
3830-55-VIP	7311518270902	1	4	55	155
3830-56-VIP	7311518152703	1	4	56	160
3830-57-VIP	7311518041878	1	4	57	165
3830-59-VIP	7311518041885	1	4	59	170

					
3830-60-VIP	7311518041892	1	4	60	177
3830-62-VIP	7311518234645	1	4	62	190
3830-64-VIP	7311518041908	1	4	64	200
3830-65-VIP	7311518041915	1	4	65	205
3830-67-VIP	7311518041922	1	4	67	215
3830-68-VIP	7311518196530	1	4	68	220
3830-70-VIP	7311518041939	1	4	70	245
3830-73-VIP	7311518041946	1	4	73	270
3830-76-VIP	7311518041953	1	4	76	285
3830-79-VIP	7311518041960	1	4	79	295
3830-83-VIP	7311518041977	1	4	83	330
3830-86-VIP	7311518041984	1	4	86	350
3830-89-VIP	7311518041991	1	4	89	370
3830-92-VIP	7311518042004	1	4	92	380
3830-95-VIP	7311518042011	1	4	95	410
3830-98-VIP	7311518042028	1	4	98	430
3830-102-VIP	7311518042035	1	4	102	455
3830-105-VIP	7311518042042	1	4	105	475
3830-108-VIP	7311518042059	1	4	108	505
3830-111-VIP	7311518042066	1	4	111	530
3830-114-VIP	7311518042073	1	4	114	570
3830-121-VIP	7311518042080	1	1	121	635
3830-127-VIP	7311518042097	1	1	127	690
3830-133-VIP	7311518042103	1	1	133	765
3830-140-VIP	7311518042110	1	1	140	815
3830-146-VIP	7311518042127	1	1	146	860
3830-152-VIP	7311518042134	1	1	152	930
3830-168	7311518040659	1	1	168	1315
3830-177-HIGH	7311518101329	1	1	177	1570
3830-210	7311518040666	1	1	210	1900

**3834-SET****BI-METAL SANDFLEX HOLESAW SETS****FEATURES:**

- Bi-metal Sandflex® holesaw sets consisting of popular sizes within the engineering industry, water and sanitation industries and the electric installation industry

**ASSORTMENT:**

								
3834-SET-42	7311518241988	51, 76, 86, 111		3834-ARBR-9100		3834-ES	1	2025
3834-SET-53	7314150127153	19, 22, 25, 29, 30, 35, 37, 41, 52, 60, 79	3834-ARBR-930	3834-ARBR-9100			1	2370
3834-SET-61	7311518266431	44, 51, 57, 73, 86, 114		3834-ARBR-9100			1	3145
3834-SET-62	7311518228040	19, 21, 22, 29, 38, 48	3834-ARBR-930	3834-ARBR-9100		BRUSH	1	1050
3834-SET-62-16/50	7311518258887	16, 20, 25, 32, 40, 50	3834-ARBR-930	3834-ARBR-9100		BRUSH	1	1065
3834-SET-65-16/51	7311518159900	16, 20, 25, 32, 40, 51	3834-ARBR-1130	3834-ARBR-11152	3834-DRL	BRUSH	1	1465
3834-SET-65-22/64	7311518159917	22, 29, 35, 44, 51, 64	3834-ARBR-1130	3834-ARBR-11152	3834-DRL		1	1625
3834-SET-72	7311518044992	19, 22, 29, 35, 44, 51, 64	3834-ARBR-930	3834-ARBR-9100			1	1080
3834-SET-73	7311518254339	16, 22, 51, 57, 73, 76, 92	3834-ARBR-930	3834-ARBR-9100			1	2080
3834-SET-73-22/68	7314150134809	22, 29, 35, 44, 51, 64, 68	3834-ARBR-1130	3834-ARBR-11152	3834-DRL		1	2170
3834-SET-77	7314150235919	16, 20, 25, 32, 41, 51, 73, 76, 83, 86	3834-ARBR-930	3834-ARBR-9100	3834-DRL		1	3325
3834-SET-86	7311518224295	25, 32, 35, 51, 54, 76, 92, 114	3834-ARBR-1130	3834-ARBR-11152	2x 3834-DRL	3834-ADP	1	2540
3834-SET-87	7311518181772	19, 22, 29, 38, 43, 48, 52, 65	3834-ARBR-930	3834-ARBR-9100	3834-DRL	3834-ES	1	1925
3834-SET-92	7311518044985	16, 22, 25, 29, 32, 41, 51, 73, 83	3834-ARBR-930	3834-ARBR-9100			1	1440
3834-SET-93	7314150414741	16, 20, 25, 32, 40, 51, 67, 76, 83	3834-ARBR-930	3834-ARBR-9100QC	3834-DRL		1	2000
3834-SET-94	7311518166458	16, 19, 22, 25, 30, 35, 41, 51, 67	3834-ARBR-1130	3834-ARBR-11152			1	1815
3834-SET-95	7311518159894	16, 19, 22, 29, 35, 44, 52, 57, 64	3834-ARBR-1130	3834-ARBR-11152	3834-DRL		1	1350
3834-SET-103	7314150134908	16, 19, 24, 29, 38, 44, 57, 67	3834-ARBR-1130	3834-ARBR-11152	3834-DRL		1	2015
3834-SET-152	7314150255658	16, 19, 22, 25, 32, 35, 44, 51, 57, 60, 65, 68, 73, 76, 83	3834-ARBR-930	3834-ARBR-9100	2x 3834-DRL		1	3770

**APPLICATION:**  
Metal sheet

**PRODUCTS:**  
Sandflex® Bi-Metal Holesaw  
Quick-Eject Arbor  
HSS Pilot Drill



# CARBIDE TIPPED HOLESAWS



55 PRODUCTS



**HIGHLY WEAR RESISTANT!**

IDEAL FOR MAKING HIGH-PRECISION HOLES IN HARD MATERIAL SUCH AS CERAMIC TILES, STONE, FIBREGLASS, LAMINATE AND HARDWOOD

EASILY CUTS THROUGH ABRASIVE MATERIAL, SUCH AS CONCRETE AND BRICK

PRECISION-GROUND CARBIDE TIPPED TEETH AT A 6-DEGREE POSITIVE TOOTH ANGLE

SIMPLE HOLESAW SELECTION THANKS TO THE PRINTED MATERIAL INFORMATION



3832

## CARBIDE TIPPED HOLESAWS



### FEATURES:







- Carbide tipped holesaws work well with everything from bricks and ceramic tiles, laminate, fibreglass and hardwood as well as difficult-to-cut steel applications
- Fit all power drills, both stationary and portable
- Knockout holes allow easy removal of cores
- Cutting depth max 38 mm (1 1/2")
- 4 teeth per inch
- Max. hole size = nominal holesaw size +1.5 mm./- 0.0







### ASSORTMENT:

All carbide tipped holesaws are packed in a cardboard box with an instruction leaflet enclosed

3832-14	7311518557744	1	6	14	30
3832-16	7311518557768	1	6	16	35
3832-17	7311518557782	1	6	17	40
3832-19	7311518557805	1	6	19	43
3832-20	7311518557812	1	6	20	45
3832-21	7311518557829	1	6	21	50
3832-22	7311518557843	1	6	22	52
3832-24	7311518557867	1	6	24	55



3832-25	7311518557881	1	6	25	58
3832-27	7311518557904	1	6	27	60
3832-29	7311518557928	1	6	29	65
3832-30	7311518557942	1	6	30	65
3832-32	7311518557966	1	6	32	70
3832-33	7311518557980	1	6	33	75
3832-35	7311518558000	1	6	35	75
3832-37	7311518558024	1	6	37	80

					
3832-38	7311518558048	1	6	38	85
3832-40	7311518558062	1	6	40	90
3832-41	7311518558086	1	6	41	93
3832-43	7311518558109	1	6	43	100
3832-44	7311518558123	1	6	44	100
3832-46	7311518558147	1	6	46	115
3832-48	7311518558161	1	6	48	120
3832-51	7311518558185	1	6	51	135
3832-52	7311518558208	1	4	52	140
3832-54	7311518558222	1	4	54	150
3832-56	7311518558239	1	4	56	160
3832-57	7311518558246	1	4	57	165
3832-59	7311518558260	1	4	59	170
3832-60	7311518558284	1	4	60	177
3832-64	7311518558307	1	4	64	200
3832-65	7311518558321	1	4	65	205
3832-67	7311518558345	1	4	67	215
3832-68	7311518558352	1	4	68	220
3832-70	7311518558369	1	4	70	245
3832-73	7311518558383	1	4	73	270

					
3832-76	7311518558406	1	4	76	285
3832-79	7311518558420	1	4	79	295
3832-83	7311518558444	1	4	83	330
3832-86	7311518558468	1	4	86	350
3832-89	7311518558482	1	4	89	370
3832-92	7311518558505	1	4	92	380
3832-95	7311518558529	1	4	95	410
3832-98	7311518558543	1	4	98	430
3832-102	7311518558567	1	4	102	455
3832-105	7311518558581	1	4	105	475
3832-108	7311518558604	1	4	108	505
3832-111	7311518558611	1	4	111	530
3832-114	7311518558628	1	4	114	570
3832-121	7311518558642	1	1	121	635
3832-127	7311518558666	1	1	127	690
3832-133	7311518558673	1	1	133	765
3832-140	7311518558680	1	1	140	815
3832-146	7311518558697	1	1	146	860
3832-152	7311518558703	1	1	152	930

# ARBORS AND PILOT DRILLS

ADAPT TO EACH SITUATION  
FOR THE BEST RESULTS

	Arbors	Pilot Drills			
HOLE SIZE UP TO 30 MM	<b>Arbors with Quick-Eject function</b> for easily removing the core				
	3834-ARBR-930EL	3834-DRL-EL	✓		
	3834-ARBR-930ESM	3834-DRL-HSS-ES		✓	
	3834-ARBR-930ES	3834-DRL-ES			✓
	<b>Standard Arbors</b>	3834-DRL-L	✓		
	3834-ARBR-630				
	3834-ARBR-730	3834-DRL		✓	
	3834-ARBR-930				
	3834-ARBR-1130	3834-DRL-CT			✓
	<b>Arbors with SDS+ shank</b> For machines with Quick-Change chucks	3834-DRL-L	✓		
3834-ARBR-SD30	3834-DRL		✓		
		3834-DRL-CT			✓
HOLE SIZE 32 MM AND BIGGER	<b>Arbors with Quick-Eject function</b> for taking out the core easily				
	3834-ARBR-9100EL	3834-DRL-EL	✓		
	3834-ARBR-9100ESM	3834-DRL-HSS-ES		✓	
	3834-ARBR-9100ES	3834-DRL-ES			✓
	<b>Quick-Change Arbors</b> for easy Holesaw changes	3834-DRL-L	✓		
	3834-ARBR-9100QC				
	3834-ARBR-11152QC	3834-DRL		✓	
	3834-ARBR-16152QC	3834-DRL-CT			✓
	<b>Power Driver™ Arbors</b> for optimal stability	3834-DRL-L	✓		
	3834-ARBR-9100				
	3834-ARBR-11152	3834-DRL		✓	
	3834-ARBR-16152	3834-DRL-CT			✓
	<b>Arbors with SDS+ shank</b> For machines with Quick-Change chucks	3834-DRL-L	✓		
3834-ARBR-SD152QC	3834-DRL		✓		
		3834-DRL-CT			✓



# QUICK-EJECT ARBOR

**QUICK-EJECT ARBOR  
SAVES TIME AND ENERGY**

QUICK-EJECT ARBOR FOR  
FAST AND EASY CORE REMOVAL

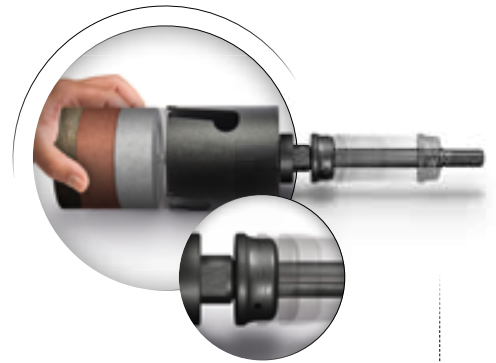

EASY QUICK-CHANGE  
FEATURE FOR FAST  
HOLESAW ATTACHMENT

CHOOSE THE RIGHT  
PILOT DRILL FOR YOUR  
APPLICATION

THE STRONG, HIGH-ALLOYED  
STEEL BODY PREVENTS WOBBLE

FAST CORE EJECTION  
SAVES TIME AND PREVENTS  
BURNT FINGERS



3834-ARBR-EL/ES

**QUICK-EJECT ARBOR**



## FEATURES:

- Arbors with a Quick-Eject function for taking out the core easily
- Arbors ending with EL are for Multi-Construction holesaws with All-round carbide drills included (Wood & Bricks)
- Arbors ending with ESM are for Bi-Metal holesaws with HSS drills included (Metal & Wood)
- Arbors ending with ES are for Carbide tipped holesaws with All-round carbide drills included (Fibreglass & Masonry)
- For enlarging existing holes, you can also buy 3834-UPSIZED that is suitable for use in combination with our Quick-Eject arbors
- All arbors are packed in retail packaging

## ASSORTMENT:

3834-ARBR-930EL	7314150265053	1	1	19-30	8.5	10	265
3834-ARBR-930ESM	7314150390465	1	1	16-30	8.5	10	235
3834-ARBR-930ES	7314150265046	1	1	16-30	8.5	10	220

3834-ARBR-9100EL	7314150265077	1	1	32-159	8.5	10	320
3834-ARBR-9100ESM	7314150390458	1	1	32-152	8.5	10	295
3834-ARBR-9100ES	7314150265060	1	1	32-152	8.5	10	285

## 3834-ARBR

# ARBORS FOR 14-30 MM HOLESAWS



### FEATURES:

- Arbors for small holesaws Ø14-30mm
- The difference is the shank size and shape
- 3834-ARBR-730 with triangular shank
- 3834-ARBR-630, -930, -1130 with hexagonal shank
- HSS Pilot drill 3834-DRL is included in all arbors, to be used for Metal & Wood applications
- Arbors can be used with Carbide holesaws but we recommend using the carbide tipped pilot drill, 3834-DRL-CT, for cutting abrasive materials
- Arbors can be used for Multi-Construction holesaws but it requires changing the drill to 3834-DRL-L
- All -C arbors are packed in retail packaging and the others are packed in a cardboard box with an instruction leaflet enclosed

### ASSORTMENT:

3834-ARBR-630	7311518015558	1	1	14-30	6.4	8	70	
3834-ARBR-630-C	7311518228576	1	1	14-30	6.4	8	70	
3834-ARBR-730	7311518167974	1	1	14-30	6.4 TRI	8	60	
3834-ARBR-730-C	7311518225674	1	1	14-30	6.4 TRI	8	60	

3834-ARBR-930	7311518015565	1	1	14-30	8.5	10	80	
3834-ARBR-930-C	7311518225681	1	1	14-30	8.5	10	80	
3834-ARBR-1130	7311518015572	1	1	14-30	11.1	13	90	
3834-ARBR-1130-C	7311518228583	1	1	14-30	11.1	13	90	

## 3834-ARBR-QC

# QUICK-CHANGE & POWER DRIVER ARBORS FOR 32-210 MM HOLESAWS



### FEATURES:

- Arbors for large holesaws Ø32-210mm
- Arbors ending with QC have a quick-change mechanism where no additional tools are needed to change the holesaw
- 3834-ARBR-9100, -11152 and -16152, are equipped with Power Driver™ that increases the strength and eliminates play of the holesaw by redistributing the load from the thread to the solid cap
- We recommend not using arbors with 8.5mm (11/32") shanks for holesaws above 100mm (4")
- An HSS Pilot drill is included in all arbors, to be used for Metal & Wood applications
- Arbors can be used with Carbide holesaws but we recommend using the carbide tipped pilot drill, 3834-DRL-CT, for cutting abrasive materials
- Arbors can be used for Multi-Construction holesaws but it requires changing the drill to 3834-DRL-L
- All -C arbors are packed in a retail packaging and the others are packed in a cardboard box with an instruction leaflet enclosed

### ASSORTMENT:

3834-ARBR-9100	7311518015589	1	1	32-100	8.5	10	250	
3834-ARBR-9100-C	7311518228590	1	1	32-100	8.5	10	250	
3834-ARBR-9100QC	7311518249830	1	1	32-100	8.5	10	160	
3834-ARBR-9100QC-C	7311518225704	1	1	32-100	8.5	10	160	
3834-ARBR-11152	7311518015596	1	1	32-152	11.1	13	260	

3834-ARBR-11152-C	7311518225698	1	1	32-152	11.1	13	260	
3834-ARBR-11152QC	7311518167967	1	1	32-152	11.1	13	250	
3834-ARBR-11152QC-C	7311518225711	1	1	32-152	11.1	13	250	
3834-ARBR-16152	7311518015602	1	1	32-210	15.4	20	310	
3834-ARBR-16152QC	7311518453152	1	1	32-210	15.4	20	300	

### 3834-ARBR-SD

## ARBORS WITH SDS+ DRIVE



#### FEATURES:

- Arbors with SDS+ drive shanks are designed for machines with quick chucks
- Simplifies the change of arbor
- SD30 is designed for small holesaws Ø14-30mm. Packed in a cardboard box
- SD152 is designed for large holesaws Ø32-152mm. Packed in a cardboard box
- An HSS Pilot drill 3834-DRL is included in all arbors, to be used for Metal & Wood applications
- Arbors can be used with Carbide holesaws but we recommend using the carbide tipped pilot drill, 3834-DRL-CT, for cutting abrasive materials
- Arbors can be used for Multi-Construction holesaws but it requires changing the drill to 3834-DRL-L

#### ASSORTMENT:

3834-ARBR-SD30	7311518203818	1	1	14-30	110

3834-ARBR-SD152QC	7311518203825	1	1	32-152	170

### 3834-DRL-HSS/-ES

## PILOT DRILLS FOR QUICK-EJECT ARBORS



#### FEATURES:

- Short Quick-Eject drills to be used for arbors with the core Quick-Eject function ending with ES and ESM
- 3834-DRL-ES is an all-round pilot drill with an integrated carbide tip to enable high cutting performance in different materials such as fibreglass, masonry and wood. To be used with carbide holesaws
- 3834-DRL-HSS-ES is an HSS pilot drill with perfect performance in both Metal & Wood applications. To be used with bi-metal holesaws
- Packed in retail packaging

#### ASSORTMENT:

				<b>A</b>	<b>B</b>	
3834-DRL-ES	7314150265091	1	1	6.35	138	45

				<b>A</b>	<b>B</b>	
3834-DRL-HSS-ES	7314150339396	1	1	6.35	138	45

### 3834-DRL-EL

## CARBIDE TIPPED PILOT DRILL FOR QUICK-EJECT ARBORS



#### FEATURES:

- All Round Carbide Tipped Pilot Drill for Quick-Eject Arbors
- Specially designed to provide one drill to cover many different materials
- Enables high cutting performance in all machinable materials, from wood and plastic to brick and light concrete
- Packed in retail packaging

#### ASSORTMENT:

				<b>A</b>	
3834-DRL-EL	7314150265114	1	1	6.35	60

### 3834-DRL

## HSS PILOT DRILL FOR ARBORS



#### FEATURES:

- To be used in combination with Bi-Metal holesaws
- 3834-DRL fits any arbor except for arbors with a Quick-Eject function
- The HSS pilot drill makes a hole in the workpiece before the teeth of the holesaw become engaged, guiding and keeping the holesaw in the correct position during the sawing operation

- The HSS pilot drill is designed for Metal & Wood applications but not for abrasive materials, such as brick
- Packed in retail packaging

#### ASSORTMENT:

Icon	Icon	Icon	Icon	A	B	Icon
3834-DRL	7311518234638	1	1	6.35	81	20

### 3834-DRL-CT/L

## CARBIDE TIPPED PILOT DRILLS FOR ARBORS



#### FEATURES:

- Drill ending with -L is for multi-construction holesaws
- Drill ending with -CT is for carbide holesaws
- These pilot drills fit any arbor except for those with the Quick-Eject function
- Carbide tipped pilot drills make a hole in the workpiece before the teeth of the holesaw become engaged, guiding and keeping the holesaw in the correct position during the sawing operation

- High grade carbide tip with special properties, hardness and geometry
- Specially designed to provide one drill to cover many different materials
- Enables high cutting performance in all machinable material from wood and plastic to brick and light concrete
- Packed in retail packaging

#### ASSORTMENT:

Icon	Icon	Icon	Icon	A	B	Icon
3834-DRL-L	7314150265138	1	1	6.35	114	25

Icon	Icon	Icon	Icon	A	B	Icon
3834-DRL-CT	7311518953201	1	1	6.35	81	35

### 3834-SCREWS

## SPARE SCREWS FOR ARBORS



#### FEATURES:

- Spare screws for arbors when changing the pilot drill
- 3834-M6x29-SET is for Quick-Eject arbors (3834-ARBR-930EL, -930ES, -930ESM, -9100EL, -9100ES, -9100ESM)
- 3834-M8x5-SET is for arbor 3834-ARBR-9100, -11152

- 3834-M8x6-SET is for arbor 3834-ARBR-630, -730, -930, -1130, -SD30, -SD152QC, -9100QC, -11152QC, -16152QC
- 3834-M8x10-SET is for arbor 3834-ARBR-16152

#### ASSORTMENT:

Icon	Icon	Icon	Icon
3834-M6X29-SET	7314150383450	3	9
3834-M8X5-SET	7314150383443	3	9

Icon	Icon	Icon	Icon
3834-M8X6-SET	7314150383436	3	9
3834-M8X10-SET	7314150383429	3	9

**3834-UPSIZ**  
**UPSIZ ADAPTOR**

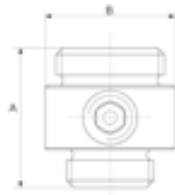

**FEATURES:**

- Upsize adaptor for enlarging existing holes
- This product should be attached to the pilot drill with the hexagon screw
- To be used for both small ( $\leq 32\text{mm}$ ) and big ( $\geq 32\text{mm}$ ) holesaws
- Works excellent together with our Quick-Eject arbors
- Packed in retail packaging

**ASSORTMENT:**

				<b>A</b>	<b>B</b>	
3834-UPSIZ	7314150344567	1	1	20.5	19	26

**3834-ADP**  
**ARBOR ADAPTOR**



**FEATURES:**

- Adapts small arbor threads ( $1/2''-20\text{ UNF}$ ) to accommodate large holesaw threads ( $5/8''-18\text{ UNF}$ )
- Not recommended for holesaws larger than  $\varnothing 44\text{ mm}$
- Fits arbor -630, -730, -930, -1130

**ASSORTMENT:**

3834-ADP	7311518454425	1	1	20

**3834-ES**  
**CORE EJECTION SPRING**



**FEATURES:**

- For pilot drills, to facilitate core removal

**ASSORTMENT:**

3834-ES	7311518454418	1	1	10

**3834-EXT**  
**ARBOR EXTENSIONS**



**FEATURES:**

- For reach in difficult-to-cut surroundings
- EXT-1 fits arbor -1130, -11152, -11152QC
- EXT-2 fits arbor -930, -9100, -9100QC

**ASSORTMENT:**

3834-EXT-1	7311518040673	1	1	11.1	330	340
3834-EXT-2	7311518168070	1	1	8.5	330	340



170

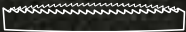
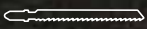



# SABRE SAW BLADES

**170**  
PRODUCTS

## PRODUCT INDEX

<i>SABRE SAW BLADES FOR METAL</i>	36
<i>SABRE SAW BLADES FOR WOOD &amp; METAL</i>	39
<i>SABRE SAW BLADES FOR WOOD</i>	42
<i>SABRE SAW BLADES FOR SPECIAL APPLICATIONS</i>	44
<i>SABRE SAW BLADES SETS</i>	46

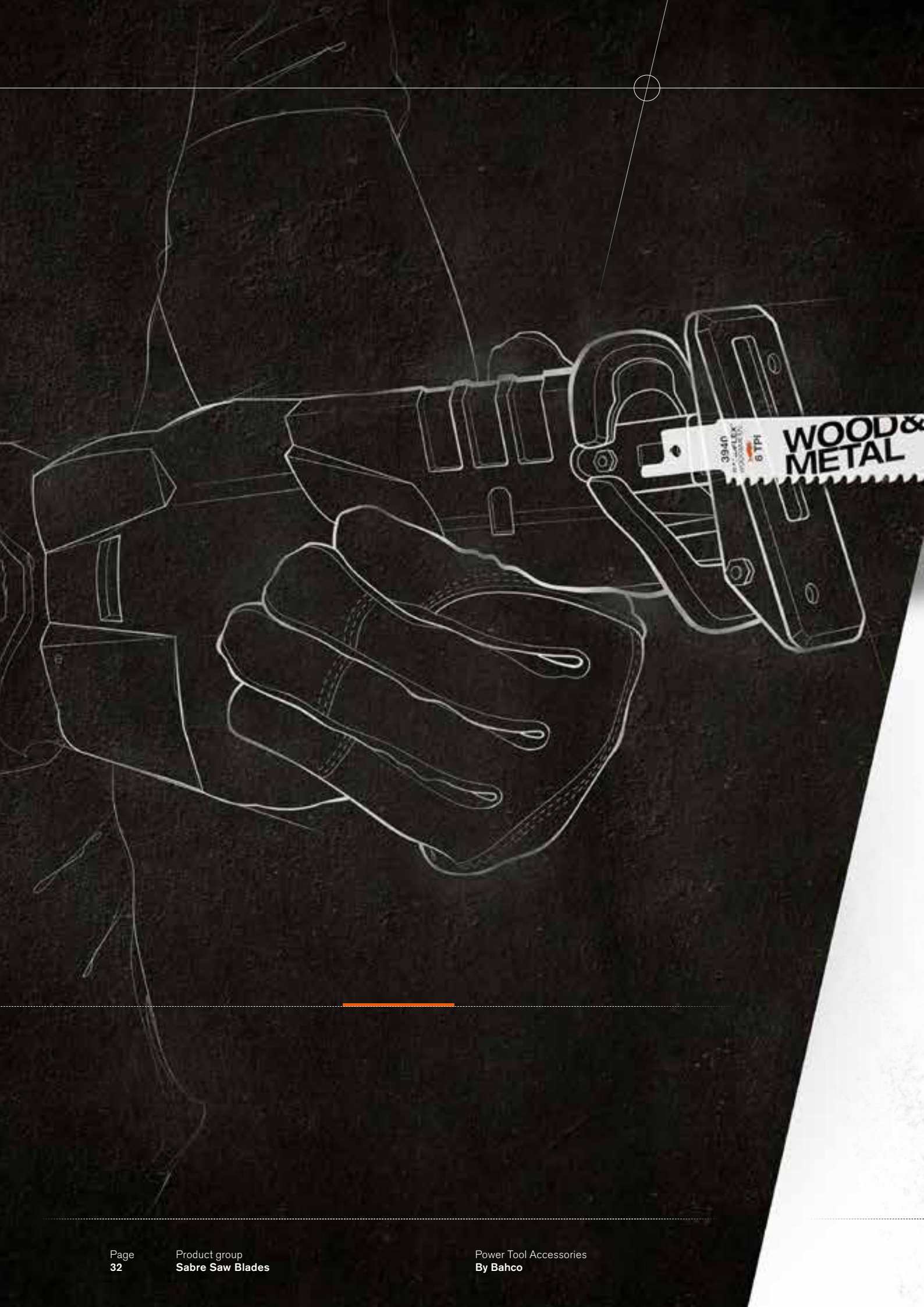



# **MANUFACTURED TO THE HIGHEST STANDARDS IN OUR FACTORY IN SWEDEN**

**BAHCO**  
MADE IN SWEDEN

170



**LONG-LIFE SANDFLEX® BI-METAL BLADES  
WITH SHARP TEETH (HSS 8% COBALT)**



**QUICK SABRE SAW BLADE SELECTION  
THANKS TO THE CLEAR BLADE MARKINGS**



**MANUFACTURED IN OUR FACTORY  
IN EUROPE – FROM THE BI-METAL PROCESS  
TO MANUFACTURING THE FINAL PRODUCT**

# FULL OF POWER

Bahco has an exceptional range of reciprocating saw blades. Each of the four separate categories has a wide range of shapes, lengths and tooting, with one for every application.

Our sabre saw blades are manufactured in our own factory in Europe – from the Bi-Metal process to manufacturing the final product. Our Bi-Metal (Sandflex®) blades are famous for their high quality and time-saving performance, and are highly respected by professionals. Our tough carbide tipped blades deliver impressive cutting power in any situation.

Whatever the task, you will produce faster, cleaner and more accurate cuts, time after time.

## FULL SUPPORT



### SELECT THE RIGHT TOOTHING (TPI)



Teeth per inch

Material thickness	≤ 3 mm	3-10 mm	11-20 mm	21-50 mm	≥ 50 mm
<b>Metal Saw Blades</b>	24	18	14 - 10 - 8/12	8/12	
<b>Metal and Wood Saw Blades</b>		10/14	10 - 8/12	6 - 5/8	4/6
<b>Wood Saw Blades</b>		11	7	7 - 5	5
<b>Special Saw Blades</b>		GRIT	6	6	3

### SABRE SAW BLADE SHAPES

Our range of sabre saw blades includes a variety of blade shapes for different styles of cutting.

<b>Standard (ST)</b> For fast and aggressive straight cuts, but still flexible for narrow cutting.	<b>Scroll (SC)</b> For contour sawing and sawing in difficult-to-reach places.	<b>Demolition (DSL)</b> Extra thick and wide saw blades for demolition and heavy-duty work.	<b>High Slope (HSL)</b> The wide body makes it highly resistant to bending, allowing straight cuts in wood.	<b>Heavy Standard (HST)</b> The wide body makes it highly resistant to bending, allowing straighter cuts.	<b>SLOPE (SL)</b> Thick blades with a narrow nose for sawing in tight spots, but highly resistant to bending.	<b>Pallet repair (PR)</b> The rounded front design prevents the blade from getting stuck.

# FULL RANGE

170  
PRODUCTS

										
<b>SABRE SAW BLADES FOR METAL</b>	 100-300 mm	✓	✓	✓	✓	✓	✓	✓		
	 150-300 mm	✓	✓	✓	✓	✓				✓
	 100-150 mm		✓			✓	✓			
	 100 mm		✓			✓		✓	✓	
<b>SABRE SAW BLADES FOR WOOD &amp; METAL</b>	 150-300 mm	✓	✓	✓						
	 150-300 mm	✓		✓	✓					
	 228 mm	✓		✓	✓	✓	✓			
	 228 mm	✓	✓							
<b>SABRE SAW BLADES FOR WOOD</b>	 228-300 mm		✓	✓						
	 228-300 mm	✓	✓							
	 228 mm			✓	✓			✓		
	 150-300 mm			✓		✓				
<b>SABRE SAW BLADES FOR SPECIAL APPLICATIONS</b>	 150-300 mm	✓	✓	✓						
	 300 mm				✓					
	 100-150 mm					✓	✓			

# SABRE SAW BLADES **FOR METAL**



86 PRODUCTS



IMPROVED BLADE DESIGN BASED ON THE APPLICATION

VIRTUALLY UNBREAKABLE SANDFLEX® BI-METAL BLADES

SIMPLE SAW BLADE SELECTION THANKS TO THE PRINTED MATERIAL INFORMATION

**MADE IN SWEDEN: FROM THE BI-METAL TO THE BLADE ITSELF**

SHARP LONG-LIFE TEETH (HSS 8% COBALT)

EASIER PENETRATION THANKS TO PRECISION-GROUND TOOTH GEOMETRY

3940-M

## SABRE SAW BI-METAL BLADES FOR METAL



### FEATURES:

- The metal blade family is designed for demanding metal cutting
- A virtually unbreakable Sandflex® bi-metal blade for all materials and type of cut
- The standard-shaped (ST) blades with high performance and precision-ground teeth
- Standard-shape (ST) for fast and aggressive straight cuts but still flexible for narrow cutting

- Slope-shaped nose for various types of cuts
- Packaging alternative 1: Retail packed either in -2P = 2 blades or -5P = 5 blades per pack
- Packaging alternative 2: Industrial pack, -10P = 10 blades or in big industrial packs -100P = 100 blades per box

### ASSORTMENT:

Icon 1	Icon 2	Icon 3	Icon 4	Icon 5	Icon 6	Icon 7	Icon 8	Icon 9
3940-100-14-ST-2P	7314150364312	2	5	100	0,9	14	ST	28
3940-100-14-ST-5P	7314150364329	5	5	100	0,9	14	ST	70
3940-100-14-ST-10P	7314150364336	10	1	100	0,9	14	ST	115
3940-100-18-ST-2P	7314150364343	2	5	100	0,9	18	ST	28
3940-100-18-ST-5P	7314150364350	5	5	100	0,9	18	ST	70
3940-100-18-ST-10P	7314150364367	10	1	100	0,9	18	ST	115
3940-150-14-ST-2P	7314150364152	2	5	150	0,9	14	ST	44
3940-150-14-ST-5P	7314150364169	5	5	150	0,9	14	ST	110
3940-150-14-ST-10P	7314150364176	10	1	150	0,9	14	ST	185
3940-150-14-ST-100P	7314150364183	100	1	150	0,9	14	ST	1765

Icon 1	Icon 2	Icon 3	Icon 4	Icon 5	Icon 6	Icon 7	Icon 8	Icon 9
3940-150-18-ST-2P	7314150364077	2	5	150	0,9	18	ST	44
3940-150-18-ST-5P	7314150364084	5	5	150	0,9	18	ST	110
3940-150-18-ST-10P	7314150364091	10	1	150	0,9	18	ST	175
3940-150-18-ST-100P	7314150364107	100	1	150	0,9	18	ST	1700
3940-228-14-ST-2P	7314150364114	2	5	228	0,9	14	ST	64
3940-228-14-ST-5P	7314150364121	5	5	228	0,9	14	ST	160
3940-228-14-ST-10P	7314150364138	10	1	228	0,9	14	ST	290
3940-228-14-ST-100P	7314150364145	100	1	228	0,9	14	ST	2780
3940-228-18-ST-2P	7314150364190	2	5	228	0,9	18	ST	68
3940-228-18-ST-5P	7314150364206	5	5	228	0,9	18	ST	170

3940-228-18-ST-10P	7314150364213	10	1	228	0,9	18	ST	295
3940-228-18-ST-100P	7314150364220	100	1	228	0,9	18	ST	3200
3940-300-14-ST-2P	7314150364237	2	5	300	0,9	14	ST	92
3940-300-14-ST-5P	7314150364244	5	5	300	0,9	14	ST	230
3940-300-14-ST-10P	7314150364251	10	1	300	0,9	14	ST	400

3940-300-14-ST-100P	7314150364268	100	1	300	0,9	14	ST	3890
3940-300-18-ST-2P	7314150364275	2	5	300	0,9	18	ST	92
3940-300-18-ST-5P	7314150364282	5	5	300	0,9	18	ST	230
3940-300-18-ST-10P	7314150364299	10	1	300	0,9	18	ST	400
3940-300-18-ST-100P	7314150364305	100	1	300	0,9	18	ST	3900

### 3940-HM

## SABRE SAW BI-METAL BLADES FOR HEAVY METAL



### FEATURES:

- The Heavy Metal blade family is designed for demanding metal cutting in thick materials
- A virtually unbreakable Sandflex® bi-metal blade for all materials and type of cut
- Version 1: Heavy standard (HST) Bi-Metal blades with precision ground teeth are a series of extra thick blades with a wider body that makes it more rigid and has a higher resistance to fracturing and bending, allowing straighter cuts

- Version 2: Standard (ST) Bi-Metal blades with coarse precision ground teeth are a series of flexible blades with a standard body that makes it more flexible and easy to bend into position
- Slope-shaped nose for various types of cuts
- Packaging alternative 1: Retail packed either in -2P = 2 blades or -5P = 5 blades per pack
- Packaging alternative 2: Industrial pack, -10P = 10 blades per box

### ASSORTMENT:

3940-150-10-HST-2P	7314150364015	2	5	150	1,07	10	HST	56
3940-150-10-HST-5P	7314150364022	5	5	150	1,07	10	HST	140
3940-150-10-HST-10P	7314150364039	10	1	150	1,07	10	HST	280
3940-150-10-ST-100P	7314150362196	100	1	150	0,9	10	ST	1850
3940-150-10-ST-2P	7314150362165	2	5	150	0,9	10	ST	44
3940-150-10-ST-5P	7314150362172	5	5	150	0,9	10	ST	110
3940-150-10-ST-10P	7314150362189	10	1	150	0,9	10	ST	190
3940-150-14-HST-2P	7314150362325	2	5	150	1,07	14	HST	56
3940-150-14-HST-5P	7314150362363	5	5	150	1,07	14	HST	140
3940-150-14-HST-10P	7314150362370	10	1	150	1,07	14	HST	275
3940-150-18-HST-2P	7314150364046	2	5	150	1,07	18	HST	60
3940-150-18-HST-5P	7314150364053	5	5	150	1,07	18	HST	150
3940-150-18-HST-10P	7314150364060	10	1	150	1,07	18	HST	280
3940-150-8/12-ST-2P	7314150362127	2	5	150	0,9	8/12	ST	44
3940-150-8/12-ST-5P	7314150362134	5	5	150	0,9	8/12	ST	110
3940-150-8/12-ST-10P	7314150362141	10	1	150	0,9	8/12	ST	180
3940-150-8/12-ST-100P	7314150362158	100	1	150	0,9	8/12	ST	1700
3940-228-10-HST-2P	7314150362387	2	5	228	1,07	10	HST	84
3940-228-10-HST-5P	7314150362394	5	5	228	1,07	10	HST	211
3940-228-10-HST-10P	7314150362400	10	1	228	1,07	10	HST	422
3940-228-10-ST-2P	7314150362080	2	5	228	0,9	10	ST	64
3940-228-10-ST-5P	7314150362097	5	5	228	0,9	10	ST	160

3940-228-10-ST-10P	7314150362103	10	1	228	0,9	10	ST	300
3940-228-10-ST-100P	7314150362110	100	1	228	0,9	10	ST	2820
3940-228-14-HST-2P	7314150362202	2	5	228	1,07	14	HST	84,5
3940-228-14-HST-5P	7314150362219	5	5	228	1,07	14	HST	211
3940-228-14-HST-10P	7314150362226	10	1	228	1,07	14	HST	422
3940-228-18-HST-2P	7314150362233	2	5	228	1,07	18	HST	84,5
3940-228-18-HST-5P	7314150362264	5	5	228	1,07	18	HST	211
3940-228-18-HST-10P	7314150362271	10	1	228	1,07	18	HST	422
3940-228-8/12-ST-2P	7314150362042	2	5	228	1,3	8/12	ST	220
3940-228-8/12-ST-5P	7314150362059	5	5	228	1,3	8/12	ST	85
3940-228-8/12-ST-10P	7314150362066	10	1	228	1,3	8/12	ST	400
3940-228-8/12-ST-100P	7314150362073	100	1	228	1,3	8/12	ST	3960
3940-300-10-HST-2P	7314150362424	2	5	300	1,07	10	HST	128
3940-300-10-HST-5P	7314150362431	5	5	300	1,07	10	HST	320
3940-300-10-HST-10P	7314150362448	10	1	300	1,07	10	HST	600
3940-300-14-HST-2P	7314150362288	2	5	300	1,07	14	HST	112
3940-300-14-HST-5P	7314150362295	5	5	300	1,07	14	HST	280
3940-300-14-HST-10P	7314150362301	10	1	300	1,07	14	HST	560
3940-300-18-HST-2P	7314150363988	2	5	300	1,07	18	HST	112
3940-300-18-HST-5P	7314150363995	5	5	300	1,07	18	HST	280
3940-300-18-HST-10P	7314150364008	10	1	300	1,07	18	HST	560

## 3940-FM

# SABRE SAW BI-METAL BLADES FOR FINE METAL



### FEATURES:

- The Fine Metal blade family is designed for metal cutting in thin materials
- A virtually unbreakable Sandflex® bi-metal blade for all materials and type of cut
- The standard-shaped (ST) blades with high performance and precision-ground teeth
- Standard-shape (ST) for fast and aggressive straight cuts but still flexible for narrow cutting
- Slope-shaped nose for various types of cuts
- Packaging alternative 1: Retail packed either in -2P = 2 blades or -5P = 5 blades per pack
- Packaging alternative 2: Industrial pack, -10P = 10 blades or in big industrial packs -100P = 100 blades per box
- Packaging alternative 1: Retail packed either in -2P = 2 blades or -5P = 5 blades per pack
- Packaging alternative 2: Industrial pack, -10P = 10 blades per box

### ASSORTMENT:

3940-100-24-ST-2P	7314150364411	2	5	100	0,9	24	ST	280		
3940-100-24-ST-5P	7314150364428	5	5	100	0,9	24	ST	70		
3940-100-24-ST-10P	7314150364435	10	1	100	0,9	24	ST	115		
3940-150-24-ST-2P	7314150364374	2	5	150	0,9	24	ST	44		

3940-150-24-ST-5P	7314150364381	5	5	150	0,9	24	ST	110		
3940-150-24-ST-10P	7314150364398	10	1	150	0,9	24	ST	190		
3940-150-24-ST-100P	7314150364404	100	1	150	0,9	24	ST	1850		

## 3940-PM

# SABRE SAW BI-METAL BLADES FOR METAL PRECISION



### FEATURES:

- The Precision Metal scroll-shaped blades with high performance and precision-ground teeth
- A virtually unbreakable Sandflex® bi-metal blade for all materials and type of cut
- Specially developed for cutting metal
- Scroll (SC) shape for contour sawing and in difficult-to-reach places
- Packaging alternative 1: Retail packed either in -2P = 2 blades or -5P = 5 blades per pack
- Packaging alternative 2: Industrial pack, -10P = 10 blades per box

### ASSORTMENT:

3940-100-14-SC-2P	7314150364466	2	5	100	0,9	14	SC	18		
3940-100-14-SC-5P	7314150364473	5	5	100	0,9	14	SC	45		
3940-100-18-SC-2P	7314150364442	2	5	100	0,9	18	SC	18		

3940-100-18-SC-5P	7314150364459	5	5	100	0,9	18	SC	45		
3940-100-24-SC-2P	7314150364558	2	5	100	0,9	24	SC	18		
3940-100-24-SC-5P	7314150364565	5	5	100	0,9	24	SC	45		

# SABRE SAW BLADES FOR WOOD & METAL

36 PRODUCTS



SIMPLE SAW BLADE SELECTION THANKS TO THE PRINTED MATERIAL INFORMATION



MADE FOR BOTH THE EMERGENCY SERVICES AND PROFESSIONAL CRAFTSMEN

VIRTUALLY UNBREAKABLE SANDFLEX® BI-METAL BLADES

IMPROVED BLADE DESIGN BASED ON THE APPLICATION



LONG-LIFE TEETH (HSS 8% COBALT)

SPECIALLY MADE FOR AGGRESSIVE STRAIGHT CUTS

3940-WM

## SABRE SAW BI-METAL BLADES FOR WOOD & METAL



### FEATURES:

- The Wood and Metal blade family is designed for demanding cutting in wood, even with embedded nails, but it can also be used for thick metal materials
- A virtually unbreakable Sandflex® bi-metal blade for all materials and types of cut
- Version 1: Slope-shaped (SL) Bi-Metal blades with precision ground teeth are a series of thicker blades with a narrow nose that makes it accessible in narrow places but still rigid and has a higher resistance to fracturing and bending, allowing straighter cuts
- Version 2: Standard (ST) Bi-Metal blades with coarse precision ground teeth are a series of flexible blades with standard body that makes it more flexible and easy to bend into position
- Packaging alternative 1: Retail packed either in -2P = 2 blades or -5P = 5 blades per pack
- Packaging alternative 2: Industrial pack, -10P = 10 blades or in big industrial packs -100P = 100 blades per box

### ASSORTMENT:

3940-150-4/6-SC-2P	7314150361823	2	5	150	1,3	4/6	SC	45	
3940-150-4/6-SC-5P	7314150361830	5	5	150	1,3	4/6	SC	105	
3940-150-4/6-SC-10P	7314150361847	10	1	150	1,3	4/6	SC	180	
3940-150-5/8-SL-2P	7314150361687	2	2	150	1,3	5/8	SL	44	
3940-150-5/8-SL-5P	7314150361700	5	5	150	1,3	5/8	SL	100	
3940-150-5/8-SL-10P	7314150361717	10	1	150	1,3	5/8	SL	180	
3940-150-5/8-SL-100P	7314150361724	100	1	150	1,3	5/8	SL	1688	
3940-150-6-ST-2P	7314150361762	2	5	150	0,9	6	ST	60	
3940-150-6-ST-5P	7314150361779	5	5	150	0,9	6	ST	140	
3940-150-6-ST-10P	7314150361786	10	1	150	0,9	6	ST	150	

3940-228-6-SL-2P	7314150361731	2	5	228	1,3	6	SL	64	
3940-228-6-SL-5P	7314150361748	5	5	228	1,3	6	SL	160	
3940-228-6-SL-10P	7314150361755	10	1	228	1,3	6	SL	330	
3940-300-6-SL-2P	7314150361793	2	5	300	1,3	6	SL	110	
3940-300-6-SL-5P	7314150361809	5	5	300	1,3	6	SL	255	
3940-300-6-SL-10P	7314150361816	10	1	300	1,3	6	SL	460	
3940-300-8/12-SL-2P	7314150361878	2	5	300	1,3	8/12	SL	104	
3940-300-8/12-SL-5P	7314150361885	5	5	300	1,3	8/12	SL	260	
3940-300-8/12-SL-10P	7314150361892	10	1	300	1,3	8/12	SL	465	
3940-300-8/12-SL-100P	7314150361908	100	1	300	1,3	8/12	SL	4650	

3940-FR

## SABRE SAW BI-METAL BLADES FOR FIRE & RESCUE



### FEATURES:

- The Fire & Rescue bi-metal blade with precision ground teeth is an extra heavy duty blade for metal/demolition applications, to be used in extreme conditions
- A virtually unbreakable Sandflex® bi-metal blade for all materials and types of cut
- Designed for use by the emergency services
- Slope-shaped for various cuts
- Packaging alternative 1: Retail packed either in -2P = 2 blades or -5P = 5 blades per pack
- Packaging alternative 2: Industrial pack, -10P = 10 blades or in big industrial packs -100P = 100 blades per box

### ASSORTMENT:

Icon 1	Icon 2	Icon 3	Icon 4	Icon 5	Icon 6	Icon 7	Icon 8	Icon 9	Icon 10
3940-228-10-DSL-2P	7314150362004	2	5	228	1,6	10	DSL	95	
3940-228-10-DSL-5P	7314150362011	5	5	228	1,6	10	DSL	238	

Icon 1	Icon 2	Icon 3	Icon 4	Icon 5	Icon 6	Icon 7	Icon 8	Icon 9	Icon 10
3940-228-10-DSL-10P	7314150362028	10	1	228	1,6	10	DSL	476	

3940-D

## SABRE SAW BI-METAL BLADES FOR DEMOLITION



### FEATURES:

- The Sandflex® Demolition slope (DSL) Bi-Metal blades are a series of extra thick and wide saw blades for demolition and heavy-duty work
- Perfect for nail-embedded wood
- A virtually unbreakable Sandflex® bi-metal blade for all materials and types of cut
- Slope-shaped for various types of cuts
- Packaging alternative 1: Retail packed either in -2P = 2 blades or -5P = 5 blades per pack
- Packaging alternative 2: Industrial pack, -10P = 10 blades or in big industrial packs -100P = 100 blades per box

### ASSORTMENT:

Icon 1	Icon 2	Icon 3	Icon 4	Icon 5	Icon 6	Icon 7	Icon 8	Icon 9	Icon 10
3940-150-5/8-DSL-2P	7314150361977	2	5	150	1,6	5/8	DSL	60	
3940-150-5/8-DSL-5P	7314150361984	5	5	150	1,6	5/8	DSL	150	
3940-150-5/8-DSL-10P	7314150361991	10	1	150	1,6	5/8	DSL	280	
3940-228-5/8-DSL-2P	7314150361915	2	5	228	1,6	5/8	DSL	120	
3940-228-5/8-DSL-5P	7314150361922	5	5	228	1,6	5/8	DSL	260	

Icon 1	Icon 2	Icon 3	Icon 4	Icon 5	Icon 6	Icon 7	Icon 8	Icon 9	Icon 10
3940-228-5/8-DSL-10P	7314150361939	10	1	228	1,6	5/8	DSL	490	
3940-300-5/8-DSL-2P	7314150361946	2	5	300	1,6	5/8	DSL	150	
3940-300-5/8-DSL-5P	7314150361953	5	5	300	1,6	5/8	DSL	370	
3940-300-5/8-DSL-10P	7314150361960	10	1	300	1,6	5/8	DSL	690	



3940-PR

## SABRE SAW BI-METAL BLADES FOR PALLET REPAIR



### FEATURES:

- The pallet repair blade is developed in close co-operation with pallet repair shops
- The unique front design prevents the blade front from getting stuck in close by wood beams when cutting nails in damaged parts of the pallet
- Virtually unbreakable Sandflex® bi-metal blade for all materials and type of cut
- By increasing the shank radius we have improved the fatigue strength
- 10/14 TPI has proved to be the most popular toothing amongst users in pallet repair shops. This toothing has good material removal rate in wood with nails and high strength to tooth breakage
- The packing quantities are 10 or 100 pcs in plastic tubes

### ASSORTMENT:

3940-228-10/14-PRO9-10P	7314150361519	10	1	228	0,9	10/14	PR	300
3940-228-10/14-PRO9-100P	7314150361526	100	1	228	0,9	10/14	PR	2900

3940-228-10/14-PR13-100P	7314150361649	100	1	228	0,9	10/14	PR	4080
3940-228-8/12-PR13-100P	7314150361601	100	1	228	1,3	8/12	PR	4045

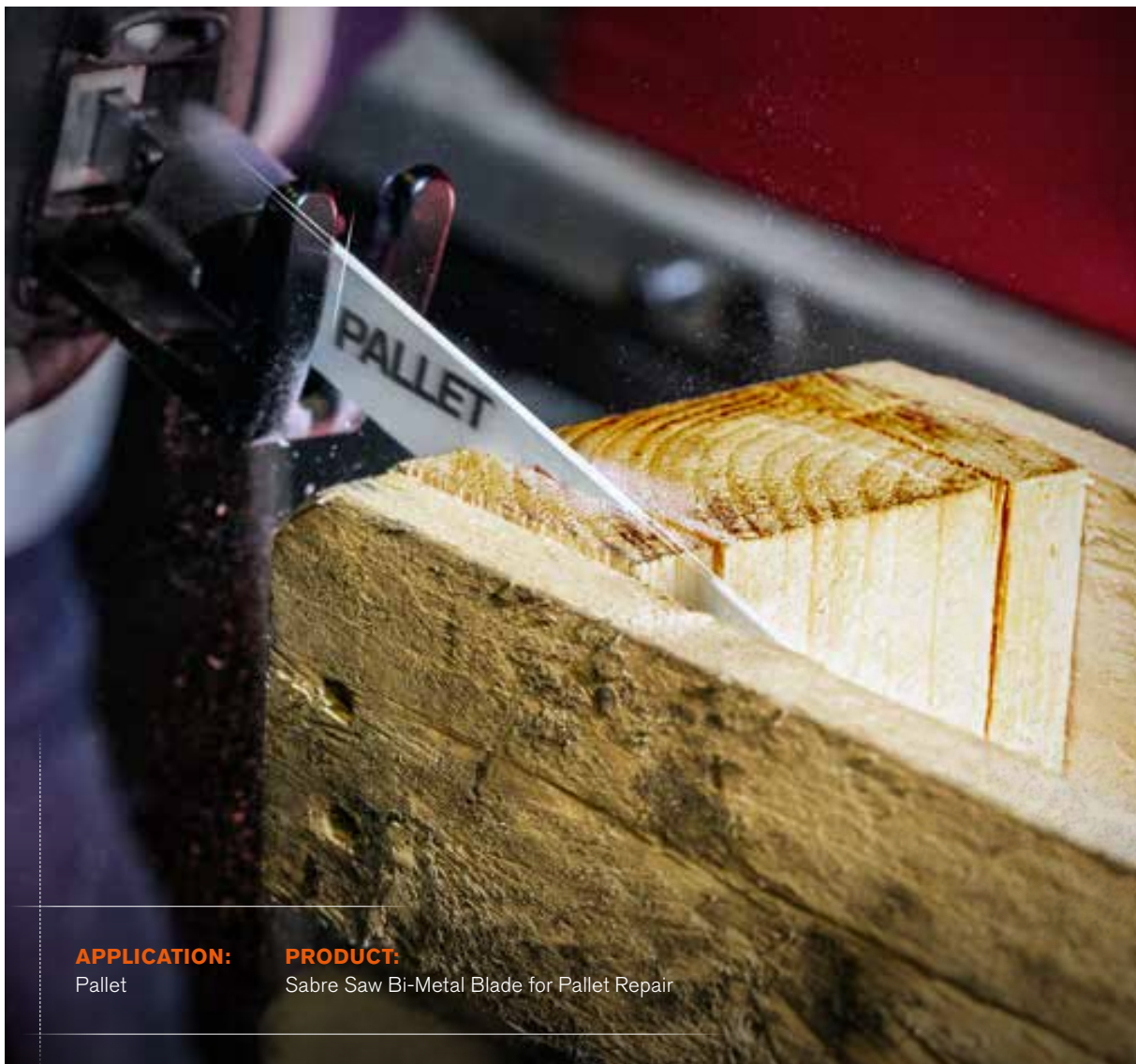

### APPLICATION:

Pallet

### PRODUCT:

Sabre Saw Bi-Metal Blade for Pallet Repair

# SABRE SAW BLADES FOR WOOD



24 PRODUCTS



SIMPLE SAW BLADE SELECTION THANKS TO THE PRINTED MATERIAL INFORMATION

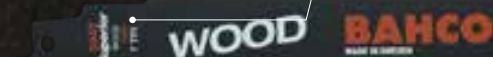

**SPECIAL TOOTHING FOR FAST CROSS-CUTTING AND RIPPING**

IMPROVED BLADE DESIGN BASED ON THE APPLICATION

STRONG HIGH-CARBON STEEL BLADES

LONG-LASTING INDUCTION-HARDENED TEETH

THE BEVEL-GROUND WOOD-CUTTING TOOTHING ALLOWS FASTER CROSS-CUTTING AND RIP-CUTTING

THE LOW-FRICTION COATING MINIMISES HEAT GENERATION

3942-W

## SABRE SAW HCS BLADES FOR WOOD



### FEATURES:

- Unique bevel-ground teeth provide a quick cut and deliver the best results in wood
- The blade is made of High Carbon Steel and the teeth are induction hardened for a very long life before being coated for minimum friction
- The toothing allows considerably faster cutting compared to traditional blades; 7 for all-round wood cut
- Packaging alternative 1: Retail packed either in -2P = 2 blades or -5P = 5 blades per pack
- Packaging alternative 2: Industrial pack, -10P = 10 blades per box

### ASSORTMENT:

3942-228-7-HSL-2P	7314150364725	2	5	228	1	7	HSL	102	
3942-228-7-HSL-5P	7314150364732	5	5	228	1	7	HSL	216	
3942-228-7-HSL-10P	7314150364749	10	1	228	1	7	HSL	408	

3942-300-7-HSL-2P	7314150364756	2	5	300	1	7	HSL	134	
3942-300-7-HSL-5P	7314150364763	5	5	300	1	7	HSL	284	
3942-300-7-HSL-10P	7314150364770	10	1	300	1	7	HSL	368	

### 3942-CW

## SABRE SAW HCS BLADES FOR COARSE WOOD



#### FEATURES:

- Unique bevel-ground teeth provide a quick cut and deliver the best results in coarse wood
- The toothing allows considerably faster cutting compared to traditional blades; 5 for coarse and very fast cuts
- The blade is made of High Carbon Steel and the teeth are induction hardened for a very long life before being coated for minimum friction

#### ASSORTMENT:

3942-228-5-HSL-2P	7314150364633	2	5	228	1	5	HSL	102	
3942-228-5-HSL-5P	7314150364640	5	5	228	1	5	HSL	216	
3942-228-5-HSL-10P	7314150364657	10	1	228	1	5	HSL	408	

3942-300-5-HSL-2P	7314150364664	2	5	300	1	5	HSL	134	
3942-300-5-HSL-5P	7314150364671	5	5	300	1	5	HSL	284	
3942-300-5-HSL-10P	7314150364688	10	1	300	1	5	HSL	368	

### 3942-WP

## SABRE SAW HCS BLADES FOR WOOD & PLASTIC



#### FEATURES:

- The blade is made of High Carbon Steel and the teeth are induction hardened for a very long life before being coated for minimum friction
- Unique bevel-ground teeth provide a quick cut and deliver the best results in wood and plastic
- The toothing allows considerably faster cutting compared to traditional blades; 11 for fine cuts

#### ASSORTMENT:

3942-228-11-HSL-2P	7314150364817	2	5	228	1	11	HSL	102	
3942-228-11-HSL-5P	7314150364824	5	5	228	1	11	HSL	216	

3942-228-11-HSL-10P	7314150364831	10	1	228	1	11	HSL	408	

### 3942-PB

## SABRE SAW BI-METAL BLADES FOR PLASTER & BOARDS



#### FEATURES:

- The Plaster and Board Bi-Metal blade is designed for demanding cutting in both plaster and different types of wooden chip boards
- Slope (SL) shape for various types of cuts
- The toothing allows considerably faster cutting compared to traditional blades
- The blade is coated for minimum friction
- A virtually unbreakable Sandflex® Bi-Metal blade for all materials and type of cut

#### ASSORTMENT:

3942-150-7-SL-2P	7314150364510	2	5	150	1,1	7	SL	46	
3942-150-7-SL-10P	7314150364534	10	1	150	1,1	7	SL	190	
3942-150-7-SL-5P	7314150364527	5	5	150	1,1	7	SL	115	
3942-228-7-SL-2P	7314150364480	2	5	228	1,1	7	SL	76	
3942-228-7-SL-5P	7314150364497	5	5	228	1,1	7	SL	190	

3942-228-7-SL-10P	7314150364503	10	1	228	1,1	7	SL	360	
3942-300-7-SL-2P	7314150364596	2	5	300	1,1	7	SL	112	
3942-300-7-SL-5P	7314150364602	5	5	300	1,1	7	SL	280	
3942-300-7-SL-10P	7314150364619	10	1	300	1,1	7	SL	525	

# SABRE SAW BLADES FOR SPECIAL APPLICATIONS



## 7 PRODUCTS

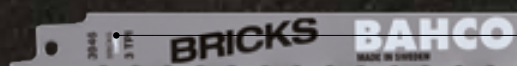

**CARBIDE TIPPED FOR CUTTING  
STONES AND BRICKS**

IMPROVED BLADE DESIGN  
BASED ON THE APPLICATION

SIMPLE SAW BLADE SELECTION  
THANKS TO THE PRINTED  
MATERIAL INFORMATION

CARBIDE TIPPED TEETH ARE IDEAL  
FOR DEMANDING APPLICATIONS

FOR FAST AND AGGRESSIVE  
STRAIGHT CUTS

## 3946-CT

### SABRE SAW CARBIDE TIPPED BLADES FOR STONE MATERIALS



#### FEATURES:

- A new wide range of 3 and 6 TPI carbide tipped blades for cutting of non-ferrous materials such as lightweight concrete, bricks, fibreglass
- Comes in two shapes, Slope (SL) shape for various types of cuts and Standard (ST) shape for fast and aggressive straight cuts

#### ASSORTMENT:

3946-150-6-SL-1P	7314150364916	1	5	150	0,9	6	SL	45
3946-228-3-ST-1P	7314150364886	1	5	228	0,9	3	ST	60
3946-228-6-ST-1P	7314150402748	1	5	228	1,3	6	ST	95

3946-300-3-ST-1P	7314150364879	1	5	300	1,5	3	ST	100
3946-300-6-ST-1P	7314150364923	1	5	300	1,3	6	ST	120

3946-CG

## SABRE SAW CARBIDE GRIT BLADES FOR TILE & GLASS

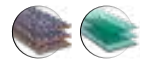

### FEATURES:

- Carbide Grit for cutting hard materials such as tiles, ceramics and glass|Shape Standard (ST)

### ASSORTMENT:

3946-100-G-ST-2P	7314150364930	2	5	100	0,9	Grit	ST	45	

3946-150-G-ST-2P	7314150364947	2	5	150	0,9	Grit	ST	120	

3944

## SABRE SAW STAINLESS STEEL BLADES FOR MEAT & ICE



### FEATURES:

- Reciprocating blade made for cutting meat/bone and frozen materials
- 3 TPI blade made in stainless steel

### ASSORTMENT:

3944-300-3-MEAT-1P	7314150364862	1	10	300	1,25	3	ST	60	

# SABRE SAW BLADE SETS

5 PRODUCTS

**ALWAYS THE RIGHT  
BLADE TO HAND**

## 3940-METAL-SET-5P

### SABRE SAW BI-METAL BLADE SET FOR METAL



#### FEATURES:

- Metal blade set with five blades for cutting metal and fine metal
- A virtually unbreakable Sandflex® bi-metal blade for all materials and type of cut
- The standard-shaped (ST) blades with high performance and precision-ground teeth
- Standard (ST) shape for fast and aggressive straight cuts but still flexible for narrow cutting

#### ASSORTMENT:

3940-METAL-SET-5P	7314150401673	1	5	125

## 3940-HDD-SET-5P

### SABRE SAW BI-METAL BLADE SET FOR HEAVY METAL & DEMOLITION



#### FEATURES:

- Set of five demolition bi-metal blades, all extra thick and wide for demolition and heavy-duty work
- Perfect for all jobs from demolition of walls with nail-embedded wood to thick steel beams
- A virtually unbreakable Sandflex® bi-metal blade for all materials and type of cut
- Three slope-shaped (SL) and two Heavy metal blades (HSL) for various types of cuts

#### ASSORTMENT:

3940-HDD-SET-5P	7314150401703	1	5	222

## 3940-MIX-SET-5P

### SABRE SAW BLADE SET FOR WOOD & METAL



#### FEATURES:

- Mixed set of five blades with metal blades for cutting metal and fine metal as well as demanding cutting in wood with embedded nails
- Three blades for metal, one for wood and metal, and one for wood

#### ASSORTMENT:

3940-MIX-SET-5P	7314150401659	1	5	150

## 3940-MIX-SET-10P

### SABRE SAW BLADE SET FOR PLASTER, WOOD & METAL



#### FEATURES:

- Mixed set of ten blades for cutting metal and fine metal as well as demanding cutting in wood, even with embedded nails
- Six blades for metal, one for wood and metal, two for wood and one for plaster and boards

#### ASSORTMENT:

3940-MIX-SET-10P	7314150401666	1	10	245

3942-WOOD-SET-5P

## SABRE SAW BLADE SET FOR WOOD



### FEATURES:

- Set of five blades for wood cutting
- Four blades in HCS for pure in-wood and plastic materials
- One blade for wood with embedded nails

### ASSORTMENT:

				
3942-WOOD-SET-5P	7314150401680	1	5	191



**APPLICATION:**  
Wood

**PRODUCT:**  
Sabre Saw HCS Blade for Wood

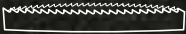
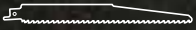

30







# JIGSAW BLADES

**30**  
PRODUCTS

## PRODUCT INDEX

<i>JIGSAW BLADES FOR METAL</i>	54
<i>JIGSAW BLADES FOR WOOD &amp; METAL</i>	55
<i>JIGSAW BLADES FOR WOOD</i>	56

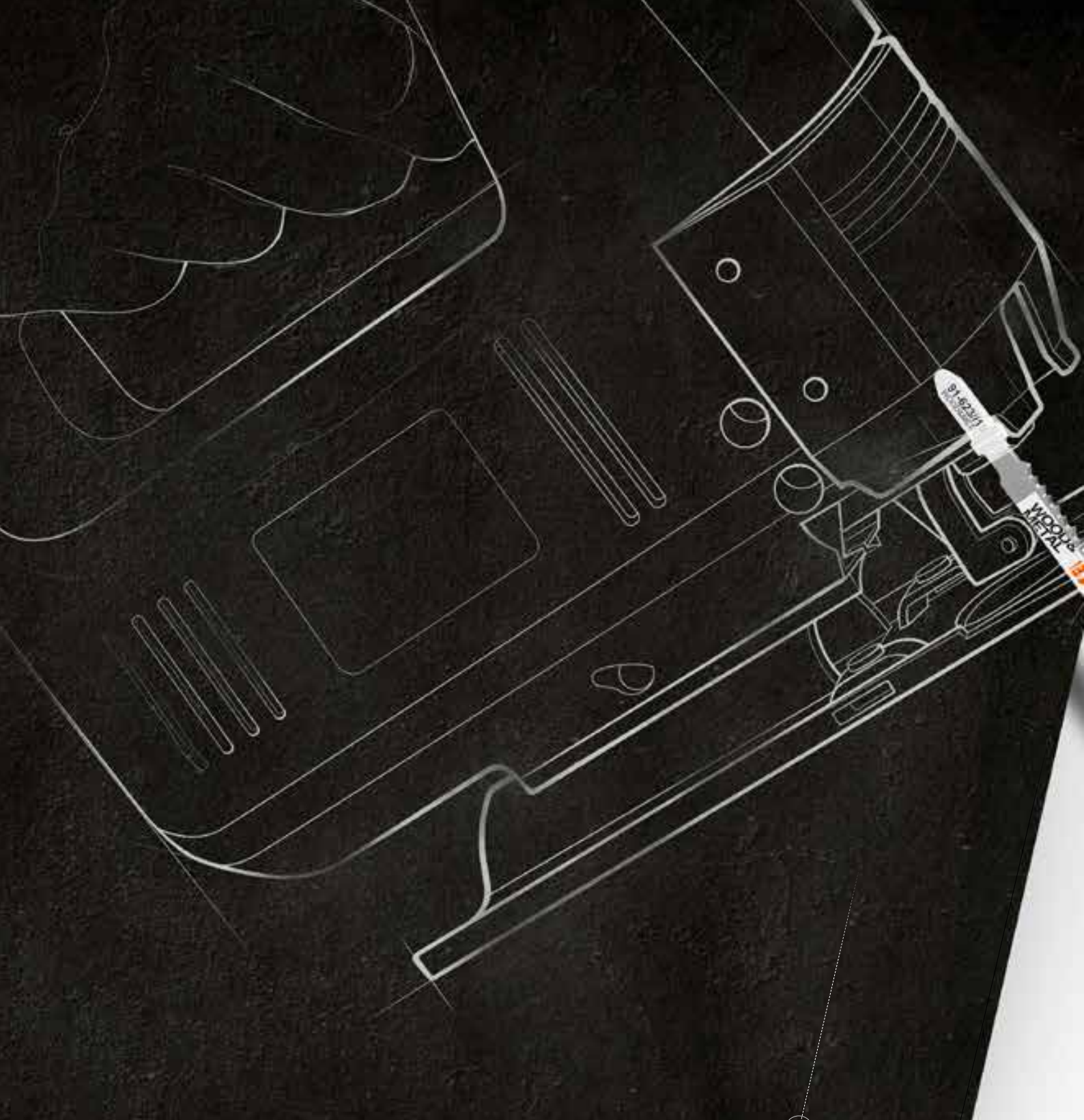

# **SAFE, PRODUCTIVE AND VIRTUALLY UNBREAKABLE BLADES**

30



**MADE OF VIRTUALLY  
UNBREAKABLE BI-METAL**



**PROGRESSIVE TOOTHING FOR  
FAST AND CLEAN CUTS**



**UNIVERSAL T-SHANK FITS ALL COMMON  
JIGSAW MACHINE BRANDS**

# FULL OF POWER

**Bahco Jigsaw Blades are easy to select and the best choice for you. For metal and wood, or aluminium and plastic, you will find a virtually unbreakable blade for every common application.**

Our range of Bi-Metal blades provide the toughness of high-speed steel with the flexibility of spring steel. These blades maintain their sharpness for a long time and can withstand immense strain. The high-speed steel (HSS) blades are ideal for cutting metal, aluminium and non-ferrous metal. The excellent high-carbon steel (HCS) blades are specially made for softer materials such as wood, laminate and plastics.

## FULL SUPPORT



### SELECT THE RIGHT TOOTHING (TPI)



Teeth per inch

Material thickness	≤ 3 mm	3-10 mm	11-20 mm	21-50 mm	≥ 50 mm
 Jigsaw Blades for metal	36 - 24	10/14 or Prog.	14 or Prog.	8 or Prog.	
 Jigsaw Blades for wood & metal		10 or Prog.	10 or Prog.	10 or Prog.	10 or Prog.
 Jigsaw Blades for wood	20	13 - 10 or 10 Rev.	10 or 10 Rev.	8-6	5

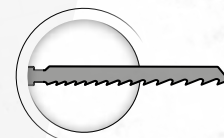

### PROGRESSIVE TOOTHING

The new progressive toothing is a bonus when cutting thin materials. The teeth then become coarser and more effective further out from the shank, allowing thicker material to be processed. The design offers a blade that works optimally in most work situations. And with a universal t-shank, the blades fit almost every jigsaw machine.

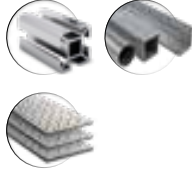

# FULL RANGE

30  
PRODUCTS

	<b>JIGSAW BLADES FOR METAL</b>	<b>JIGSAW BLADES FOR WOOD &amp; METAL</b>	<b>JIGSAW BLADES FOR WOOD</b>
<b>Range</b>	 3-16 mm (Head Diameter)	 3-16 mm (Head Diameter)	 3-16 mm (Head Diameter)
<b>Application</b>			



# JIGSAW BLADES FOR METAL

10 PRODUCTS



**SHATTERPROOF  
BI-METAL BLADES**

POWERFUL LONG-LASTING  
BI-METAL BLADES

IMPROVED BLADE DESIGN  
BASED ON THE APPLICATION

SIMPLE SAW BLADE SELECTION THANKS  
TO THE PRINTED MATERIAL INFORMATION

UNIVERSAL T-SHANK FITS ALL COMMON  
JIGSAW MACHINE BRANDS

ALL-ROUND METAL  
CUTTING TOOTHING

91-M

## JIGSAW BLADES FOR METAL

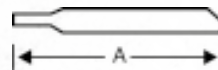

### FEATURES:

- These blades fit AEG, Atlas Copco, Bosch, DeWalt, Hitachi, Makita, Metabo, Milwaukee and similar machines
- Standardised T-Shank (also referred to as Euro shank)
- Type of blades:
  - HSS: High Speed Steel is long lasting and will cut through most materials
  - BiM: Bi-metal combines the cutting performance of HSS with the flexibility of carbon steel, the saw blades are shatterproof and suitable for cutting through all types of material
  - CT: Carbide Tipped, for abrasive materials. Ceramics, reinforced plastic, marble, glass
  - HM: Hard Metal

- A new progressive toothing has been introduced on our universal progressive blade
- The progressivity gives many fine teeth close to the shank, good when cutting thin material, the teeth then become coarser and more effective further out from the shank, allowing thicker material to be processed
- Packaging: -5P = 5 blades packed on informative card -1P = 1 blade packed on informative card

### ASSORTMENT:

Product Code	Material	Teeth	Length (mm)	Material	Teeth	Length (mm)	Material	Teeth	Length (mm)
91-3PM-5P	7311518260156	5	1	Prog	100	2	HSS	45	
91-433-5P	7311518260101	5	1	8	100	2	HSS	45	
91-502-5P	7311518032746	5	1	36	75	1	HSS	45	
91-512-5P	7311518032753	5	1	24	75	2	HSS	45	
91-517-5P	7311518032777	5	1	24	75	2	HSS	45	

Product Code	Material	Teeth	Length (mm)	Material	Teeth	Length (mm)	Material	Teeth	Length (mm)
91-522-5P	7311518032784	5	1	14	75	2	HSS	45	
91-611-5P	7311518260071	5	1	24	132	1	BiM	45	
91-612-5P	7311518032814	5	1	24	75	2	BiM	45	
91-622-5P	7311518260088	5	1	14	75	1	BiM	45	
91-7V1-5P	7311518260118	5	1	10/14	132	2	BiM	45	

# JIGSAW BLADES FOR WOOD & METAL

## 3 PRODUCTS



**BLADES FIT ALL COMMON  
JIGSAW MACHINES**

POWERFUL LONG-LASTING  
BI-METAL BLADES

IMPROVED BLADE DESIGN  
BASED ON THE APPLICATION

UNIVERSAL T-SHANK FITS ALL COMMON  
JIGSAW MACHINE BRANDS

SUITABLE FOR CUTTING  
THROUGH ALL TYPES OF MATERIAL

SIMPLE SAW BLADE SELECTION THANKS  
TO THE PRINTED MATERIAL INFORMATION

## 91-WM

### JIGSAW BLADES FOR WOOD & METAL

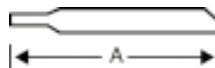

#### FEATURES:

- These blades fit AEG, Atlas Copco, Bosch, DeWalt, Hitachi, Makita, Metabo, Milwaukee and similar machines
- Standardised T-Shank (also referred to as Euro shank)
- Type of blades:  
HCS: Carbon Steel, is suitable for cutting through wood, plastic and other soft materials  
BiM: Bi-metal combines the cutting performance of HSS with the flexibility of carbon steel, the saw blades are shatterproof and suitable for cutting through all types of material

- A new progressive toothing has been introduced on our universal progressive blade
- The progressivity offers many fine teeth close to the shank, good when cutting thin material, the teeth then become coarser and more effective further out from the shank, allowing thicker material to be processed
- Packaging:-5P = 5 blades packed on informative card

#### ASSORTMENT:

Product Code	Material	Length (mm)	Width (mm)	Teeth	Shank	Material	Weight (g)
91-2PW-5P	7311518260163	5	1	Prog	116	2	HCS 45
91-4PWM-5P	7311518260170	5	1	Prog	132	2	BiM 45

Product Code	Material	Length (mm)	Width (mm)	Teeth	Shank	Material	Weight (g)
91-623-5P	7311518260064	5	1	10	116	2	BiM 45

# JIGSAW BLADES FOR WOOD

12 PRODUCTS



DESIGNED FOR FAST  
ALL-ROUND WOOD CUTTING

POWERFUL LONG-LASTING BLADES  
MADE OF HIGH CARBON STEEL

IMPROVED BLADE DESIGN  
BASED ON THE APPLICATION

SIMPLE SAW BLADE SELECTION THANKS  
TO THE PRINTED MATERIAL INFORMATION

UNIVERSAL T-SHANK FITS ALL COMMON  
JIGSAW MACHINE BRANDS

FAST WOOD CUTTING TOOTHING

91-W

## JIGSAW BLADES FOR WOOD

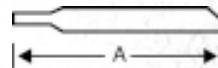

### FEATURES:

- These blades fit AEG, Atlas Copco, Bosch, DeWalt, Hitachi, Makita, Metabo, Milwaukee and similar machines
- Standardised T-Shank (also referred to as Euro shank)
- Type of blades:  
HCS: Carbon Steel, is suitable for cutting through wood, plastic and other soft materials  
BiM: Bi-metal combines the cutting performance of HSS with the flexibility of carbon steel, the saw blades are shatterproof and suitable for cutting through all types of material. A new progressive toothing has been introduced on our universal progressive blade

- The progressivity offers many fine teeth close to the shank, good when cutting thin material, the teeth then become coarser and more effective further out from the shank, allowing thicker material to be processed
- Packaging: -5P = 5 blades packed on informative card \* reversed teeth

### ASSORTMENT:

							A			
91-434-5P	7311518260026	5	1	8	116	1	BiM	45		
91-444-5P	7311518260033	5	1	6	152	3	BiM	45		
91-023-5P	7311518032593	5	1	8	100	2	HCS	45		
91-027-5P	7311518032616	5	1	13	83	2	HCS	45		
91-143-5P	7311518032630	5	1	6	100	3	HCS	45		
91-148-5P	7311518032654	5	1	6	100	3	HCS	45		

							A			
91-223-5P	7311518032661	5	1	10	100	1	HCS	45		
91-226-5P	7311518032685	5	1	10	100	*1	HCS	45		
91-243-5P	7311518032692	5	1	6	100	1	HCS	45		
91-412-5P	7311518260040	5	1	20	76	1	BiM	45		
91-443-5P	7311518032722	5	1	6	100	1	BiM	45		
91-233-5P	7311518260057	5	1	8	116	1	HCS	45		





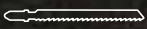
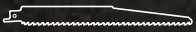

66

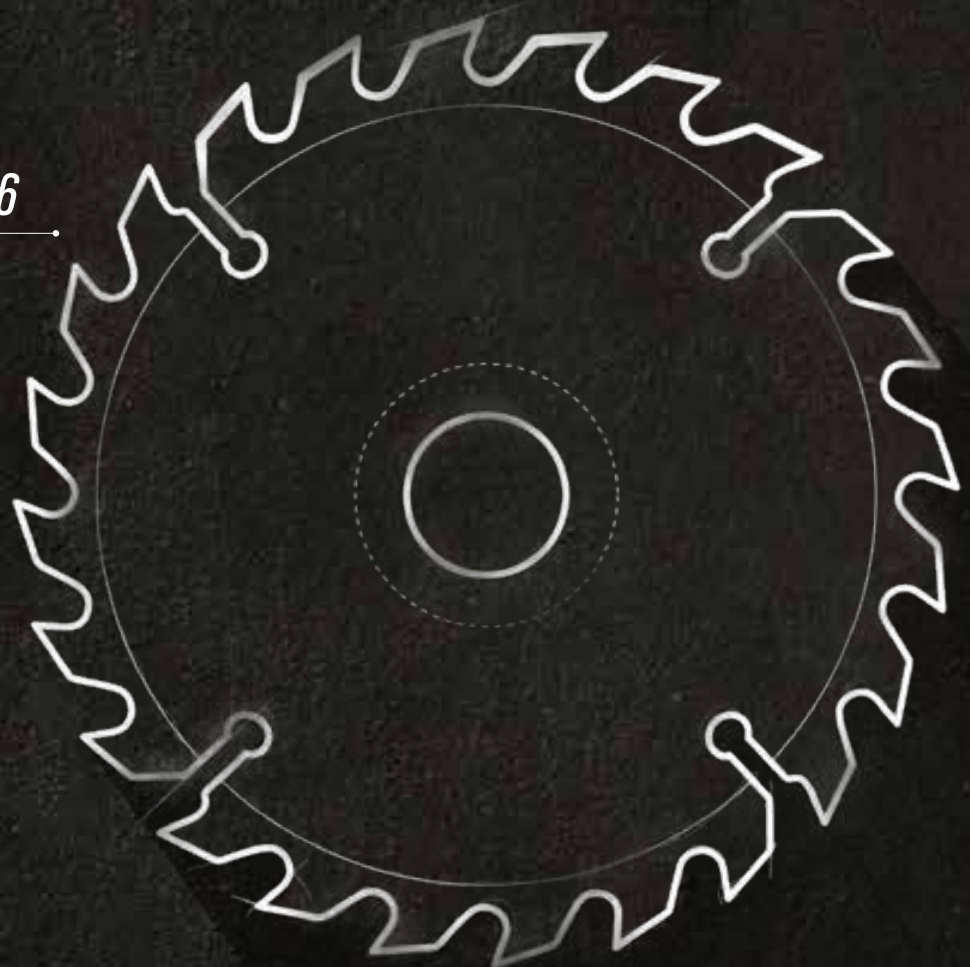



# **CIRCULAR SAW BLADES**

## **PRODUCT INDEX**

**66**  
PRODUCTS

*CIRCULAR SAW BLADES FOR WOOD* 64

*CIRCULAR SAW BLADES  
FOR ALUMINIUM AND PLASTIC* 67



**BAHCO**

8501-165-20-24C

24T



20mm  $\varnothing$

165mm  $\varnothing$



MAX RPM  
8000

**MEDIUM  
WOOD**

# **POWERFUL BLADES MAKE WOOD CUTTING EASY AND PRECISE**

66



**THE CORDLESS BLADES HAVE AN ULTRA-THIN KERF TO CONSUME LESS POWER AND INCREASE EFFICIENCY WHILE CUTTING**



**HIGH-TECH PRECISION BRAZING PROCESS TO ENSURE ACCURATE AND STRONG FIXTURE OF THE CARBIDE TEETH**



**EXPANSION SLOTS KEEP THE BLADE FLAT AS THE BLADE WILL EXPAND AND CONTRACT DUE TO HEAT GENERATION**

# FULL OF POWER

**We are committed to providing the best cutting tools for every application and machine. That's why our circular saw blades are built to last and give you strong performance every time.**

Our assortment of circular saw blades has been designed to simplify the selection of blades for your needs. Depending on your machine, you can easily identify the correct blade to use. We have two well-known tooth shapes that are suitable for most applications.

## FULL SUPPORT

### GRINDING



#### Alternate Top Bevel (ATB)

ATB is the most common toothing for wood cutting. Suitable for all sorts of cutting and provides a clean finish.



#### Triple Chip Grind (TCG)

TCG/Trapezoidal blades provide balanced cutting force, low tooth drag and better chip clearance. This tooth shape prevents chipping in brittle materials. Use TCG blades when cutting plastics, aluminium and non-ferrous metals.

### EASY SELECT:

#### THE TYPE OF MACHINE



#### BLADE DIMENSION

30mm Ø

← 210mm Ø



#### MATERIAL TO CUT

MEDIUM  
WOOD

### HOOK (RAKER) ANGLES



#### POSITIVE HOOK ANGLE: 5-23°

Portable and table saws require a positive angle to progress into the workpiece. A higher angle provides more aggressive cuts. Plunge saws have a 5° angle to be less aggressive when performing plunge cuts. ATB for wood cutting.



#### NEUTRAL HOOK ANGLE: 0°

Machines that cut from above like mitre-and-chop saws have a neutral hook angle to avoid lifting the workpiece. With a neutral hook it will push the workpiece into the work surface. ATB for wood cutting.







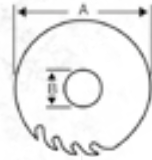

#### NEGATIVE HOOK ANGLE: -5°

The negative hook angle provides maximum control of the feed speed as it prevents self-feeding of materials. Use a negative hook angle when cutting metal. TCG in combination with a negative hook angle makes it perfect for cutting aluminium and other non-ferrous metals.

# FULL RANGE

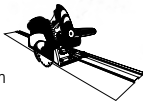
66  
PRODUCTS



	Blade size (A)	Bore size (B)	● Coarse Wood	● Medium Wood	● Fine Wood	● Alu. & Plastic
<b>Cordless saws</b> 136-190mm 	136	10		8501-136-10-24C		
	136	20		8501-136-20-24C		
	150	10		8501-150-10-24C		
	160	20		8501-160-20-24C		
	165	20		8501-165-20-24C		
	184	20	8501-184-20-24C			
	190	30	8501-190-30-24C			
<b>Plunge saws</b> 160-210mm 	160	20			8501-160-20-48XF	
	165	20			8501-165-20-48XF	
	210	30			8501-210-30-60XF	
<b>Portable saws</b> 125-250mm 	125	20	8501-2			
	130	20	8501-3			
	140	20	8501-4	8501-4F	8501-4XF	
	150	20	8501-5	8501-5F		
	160	20	8501-7	8501-7F		
	170	30	8501-10	8501-10F		
	180	30	8501-12	8501-12F		
	184	30	8501-184-16-24	8501-184-16-40		
	184	16	8501-13	8501-13F		
190	30	8501-15	8501-15F	8501-190-30-60XF		
<b>Table saws</b> 200-250mm 	200	30	8501-16	8501-16F		
	210	30	8501-17	8501-17F	8501-210-30-60XF	
	230	30	8501-22	8501-22F	8501-230-30-60XF	
	235	30	8501-23	8501-23F	8501-235-30-60XF	
	250	30	8501-28	8501-28F	8501-28XF	
<b>Site saws</b> 300-400mm 	300	30	8501-30	8501-30F	8501-30XF	
	315	30	8501-31	8501-31F		
	400	30	8501-40			
<b>Mitre saws</b> 210-305mm 	210	30		8501-210-30-48SW		8501-17S
	216	30	8501-16SW	8501-18SW	8501-216-60SW	8501-18S
	250	30			8501-28SW	8501-28S
	260	30	8501-260-24SW	8501-260-40SW	8501-260-60SW	8501-260-30-80S
	300	30			8501-30SW	8501-30S
	305	30		8501-305-30-40SW	8501-305-30-60SW	8501-305-30-96S

# CIRCULAR SAW BLADES FOR WOOD

60 PRODUCTS



ALL SAW BLADES HAVE CLEAR USER COMMUNICATION

THE ATB TOOTH SHAPE PROVIDES A CLEAN FINISH FOR WOOD CUTTING

THE BLADES FOR CORDLESS ENSURE LONGER BATTERY LIFE THANKS TO THE ULTRA-THIN KERF DESIGN



THE CARBIDE-TIPPED TEETH ARE CEMENTED TO THE HARDENED COLD-ROLLED STEEL BLADE

REDUCING RINGS ARE SUPPLIED FOR SOME BLADES TO ENSURE THAT THE BLADES FIT SAFELY IN YOUR MACHINE WHEN THE BLADE BORE SIZE IS DIFFERENT.



## 8501-C

### CIRCULAR SAW BLADES FOR WOOD IN CORDLESS SAWS

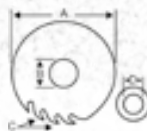

#### FEATURES:

- Carbide tipped circular saw blades for Cordless saw machines in wood applications
- An ultra-thin kerf provides less energy consumption for your cordless machine
- The thin blades give smooth and efficient cuts
- Positive hook angle

- Blades are made of hardened cold rolled steel
- Expansion slots to take up the expansion of the steel when in use
- Reducing rings (measurement D) are available for some blades to decrease the inner diameter if needed
- Packed in retail packaging

#### ASSORTMENT:

				A	B	C	D		
8501-136-10-24C	7314150371471	1	1	136	10	24		●	150
8501-136-20-24C	7314150371488	1	1	136	20	24	16	●	149
8501-150-10-24C	7314150403004	1	1	150	10	24		●	177
8501-160-20-24C	7314150403011	1	1	160	20	24	16	●	284

				A	B	C	D		
8501-165-20-24C	7314150403028	1	1	165	20	24	16, 10	●	240
8501-184-20-24C	7314150403042	1	1	184	20	24		●	277
8501-190-30-24C	7314150403059	1	1	190	30	24		●	302



## 8501-P/T

# CIRCULAR SAW BLADES FOR WOOD IN PORTABLE & TABLE SAWS



### FEATURES:

- Carbide tipped circular saw blades for Portable-/Table saw machines in wood applications
- Positive hook angle
- Blades are made of hardened cold rolled steel
- Expansion slots to take up the expansion of the steel when in use
- Reducing rings (measurement D) are available for some blades to decrease the inner diameter if needed
- Packed in retail packaging

### ASSORTMENT:

				A	B	C	D		
8501-2	7311518004743	1	1	125	20	16	16, 13, 12,7	●	120
8501-3	7311518004750	1	1	130	20	16	16, 13	●	130
8501-4	7311518008079	1	1	140	20	16	16, 13	●	155
8501-4F	7311518220914	1	1	140	20	24	16, 13	●	165
8501-4XF	7311518281786	1	1	140	20	30	16, 13	●	235
8501-5	7311518004774	1	1	150	20	18	16, 13	●	180
8501-5F	7311518220921	1	1	150	20	30	16, 13	●	190
8501-7	7311518004798	1	1	160	20	18	16	●	200
8501-7F	7311518220938	1	1	160	20	30	16	●	210
8501-10	7311518004828	1	1	170	30	18	20, 16	●	215
8501-10F	7311518220945	1	1	170	30	30	20, 16	●	250
8501-12	7311518004842	1	1	180	30	20	20, 16	●	250
8501-12F	7311518220952	1	1	180	30	40	20, 16	●	370
8501-13	7311518004859	1	1	184	30	24	28.6, 20	●	275
8501-13F	7311518220969	1	1	184	30	40	28.6, 20	●	285
8501-184-16-24	7314150402946	1	1	184	16	24		●	366
8501-184-16-40	7314150402953	1	1	184	16	40		●	366

				A	B	C	D		
8501-15	7311518004873	1	1	190	30	20	20	●	290
8501-15F	7311518220976	1	1	190	30	40	20	●	310
8501-190-30-60XF	7314150402960	1	1	190	30	60	20	●	428
8501-16	7311518004880	1	1	200	30	20	25, 20, 18, 16	●	320
8501-16F	7311518220983	1	1	200	30	40	25, 20, 18, 16	●	335
8501-17	7311518004897	1	1	210	30	20	25, 20, 16	●	350
8501-17F	7311518220990	1	1	210	30	40	25, 20, 16	●	385
8501-210-30-60XF	7314150402977	1	1	210	30	60	25, 20, 16	●	562
8501-22	7311518178888	1	1	230	30	20	25, 16	●	500
8501-22F	7311518221003	1	1	230	30	40	25, 16	●	530
8501-230-30-60XF	7314150402984	1	1	230	30	60	25, 16	●	712
8501-23	7311518004958	1	1	235	30	30	25, 16	●	560
8501-23F	7311518018887	1	1	235	30	40	25, 16	●	560
8501-235-30-60XF	7314150402991	1	1	235	30	60	25, 16	●	701
8501-28	7311518018894	1	1	250	30	24	25, 20, 16	●	650
8501-28F	7311518221010	1	1	250	30	40	25, 20, 16	●	650
8501-28XF	7311518281946	1	1	250	30	60	25, 20, 16	●	795

## 8501-S

# CIRCULAR SAW BLADES FOR WOOD IN SITE SAWS



### FEATURES:

- Carbide tipped circular saw blades for Site saw machines in wood applications
- Positive hook angle
- Blades are made of hardened cold rolled steel
- Expansion slots to take up the expansion of the steel when in use
- Reducing rings (measurement D) are available for some blades to decrease the inner diameter if needed
- Packed in retail packaging

### ASSORTMENT:

				A	B	C	D		
8501-30	7311518237479	1	1	300	30	30	20	●	1445
8501-30F	7311518237462	1	1	300	30	40	20	●	1100
8501-30XF	7311518281984	1	1	300	30	60	20	●	1470

				A	B	C	D		
8501-31	7311518237455	1	1	315	30	30	25	●	1570
8501-31F	7311518237448	1	1	315	30	40	20	●	1300
8501-40	7311518282042	1	1	400	30	40	25	●	2760

**8501-P**

**CIRCULAR SAW BLADES FOR WOOD IN PLUNGE SAWS**

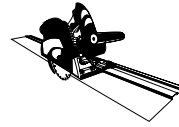

**FEATURES:**

- Carbide tipped circular saw blades for Plunge saw machines in wood applications
- 5° Positive hook angle
- Blades are made of hardened cold rolled steel
- Expansion slots to take up the expansion of the steel when in use
- Reducing rings (measurement D) are available for some blades to decrease the inner diameter if needed
- Packed in retail packaging

**ASSORTMENT:**

Icon 1	Icon 2	Icon 3	Icon 4	A	B	C	D	Icon 5	Icon 6
8501-160-20-48XF	7314150402892	1	1	160	20	48			303

Icon 1	Icon 2	Icon 3	Icon 4	A	B	C	D	Icon 5	Icon 6
8501-165-20-48XF	7314150402908	1	1	165	20	48			311

**8501-M**

**CIRCULAR SAW BLADES FOR WOOD IN MITRE SAWS**



**FEATURES:**

- Carbide tipped circular saw blades for Mitre saw machines in wood applications
- 0° Neutral hook angle
- Blades are made of hardened cold rolled steel
- Expansion slots to take up the expansion of the steel when in use
- Reducing rings (measurement D) are available for some blades to decrease the inner diameter if needed
- Packed in retail packaging

**ASSORTMENT:**

Icon 1	Icon 2	Icon 3	Icon 4	A	B	C	D	Icon 5	Icon 6
8501-210-30-48SW	7314150403066	1	1	210	30	48			569
8501-16SW	7314150258642	1	1	216	30	24	25		550
8501-18SW	7311518221058	1	1	216	30	48	25		635
8501-216-60SW	7314150359448	1	1	216	30	60			597
8501-28SW	7311518221065	1	1	250	30	60	25, 20, 16		795
8501-260-24SW	7314150359479	1	1	260	30	24			868

Icon 1	Icon 2	Icon 3	Icon 4	A	B	C	D	Icon 5	Icon 6
8501-260-40SW	7314150359462	1	1	260	30	40			873
8501-260-60SW	7314150359455	1	1	260	30	60			866
8501-30SW	7311518282196	1	1	300	30	60	20		1400
8501-305-30-40SW	7314150403073	1	1	305	30	40			1340
8501-305-30-60SW	7314150403080	1	1	305	30	60			1340

# CIRCULAR SAW BLADES FOR ALUMINIUM AND PLASTIC



## 6 PRODUCTS



A 5° NEGATIVE HOOK ANGLE WITH TRAPEZOIDAL TOOTHING FOR MAXIMUM CONTROL

A 5° NEGATIVE HOOK ANGLE WITH TRAPEZOIDAL TOOTHING

THE CARBIDE-TIPPED TEETH ARE CEMENTED TO THE HARDENED COLD ROLLED STEEL BLADE

LASER-CUT EXPANSION SLOTS DISPERSE HEAT AND PREVENT THE BLADE FROM WARPING



## 8501-AP

### CIRCULAR SAW BLADES FOR ALUMINIUM & PLASTIC IN MITRE SAWS



#### FEATURES:

- Carbide tipped circular saw blades for Mitre saw machines in aluminium and plastic applications
- 5° Negative hook angle
- Trapezoidal grinding for cutting aluminium and plastics
- Blades are made of hardened cold rolled steel

- Expansion slots to take up the expansion of the steel when in use
- Reducing rings (measurement D) are available for some blades to decrease the inner diameter if needed
- Packed in retail packaging

#### ASSORTMENT:

				A	B	C	D		
8501-17S	7311518221027	1	1	210	30	48	25	●	580
8501-18S	7311518221034	1	1	216	30	48	25	●	595
8501-28S	7311518221041	1	1	250	30	80	25, 20, 16	●	770

				A	B	C	D		
8501-260-30-80S	7314150403097	1	1	260	30	80	25	●	866
8501-30S	7311518282240	1	1	300	30	96	20	●	1370
8501-305-30-96S	7314150403103	1	1	305	30	96		●	1340

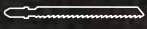
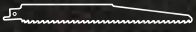

5





# **PORTABLE BAND SAW BLADES**

## **PRODUCT INDEX**

*EASY-CUT PORTABAND*

73

**5**

**PRODUCTS**



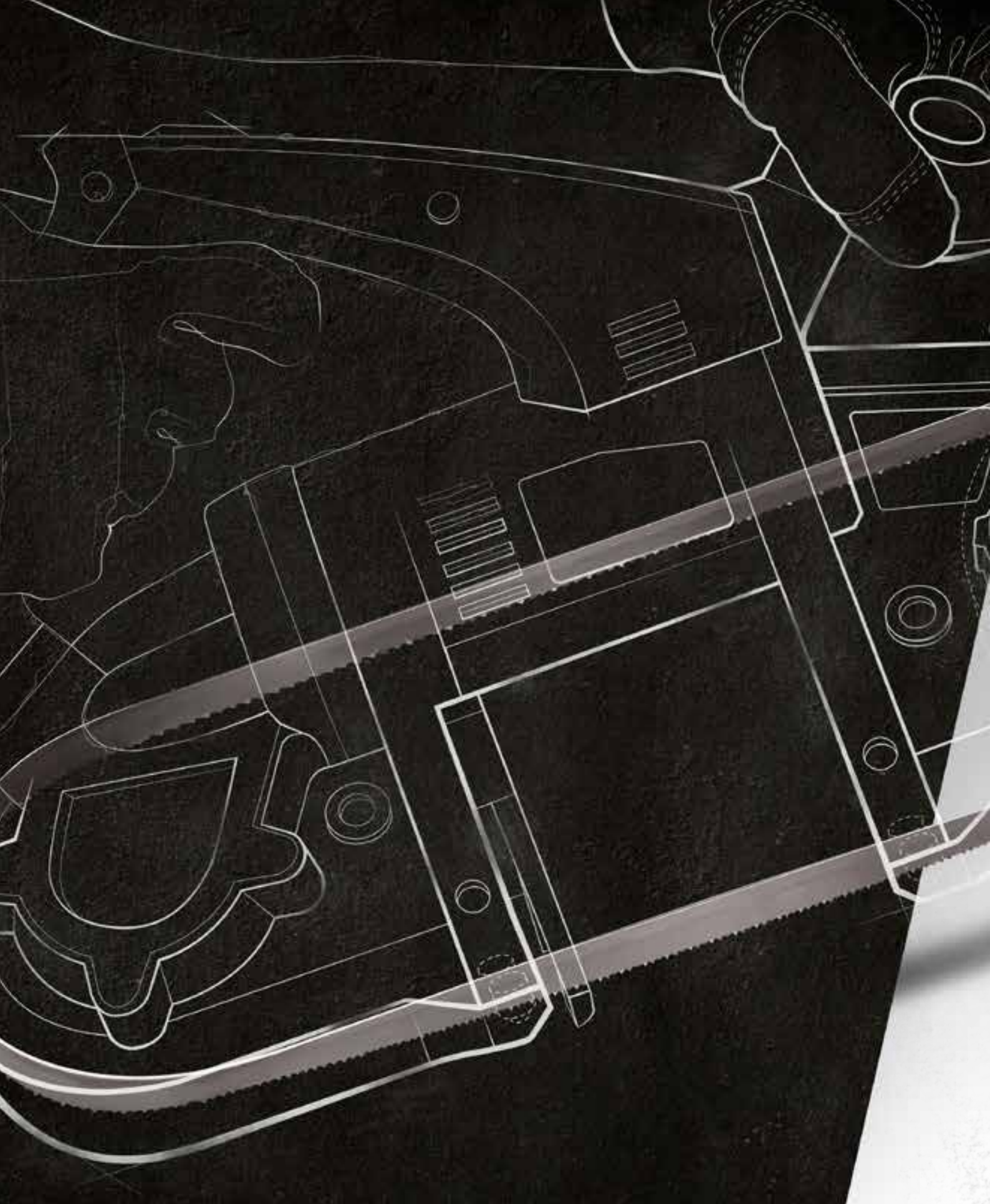

# **ONE BLADE** **CUTS ALL!**

5



**ONE BLADE FOR A WIDE  
RANGE OF MATERIALS, SHAPES  
AND DIAMETERS**



**PATENTED ANTI-TOOTH-  
STRIPPING DESIGN**



**FIT ALL COMMON PORTABLE  
BAND SAW MACHINES**

# FULL OF POWER



The Bi-Metal Portable Band Saw Blade is based on the idea of one blade cuts all. This easy-cut geometry provides a wider operating range than a conventional blade of similar TPI. This allows a smaller number of blades which still cover all material types and sizes.

Our Band Saw blades are made of Bi-Metal; High-Speed Steel tooth tips combined with flexible alloy-steel backing material. This gives you the most cost-effective band saw blades for most metal sawing applications.

We produce these Bi-Metal blades in our own factories in Europe – both the Bi-Metal and the saw itself. Even the testing takes place in our own R&D centre. That's why our cutting heritage is respected by professionals and is famous for its high-quality and 'time-per-cut'.

## FULL SUPPORT

### CUT IT ALL!

Easy-cut blades cut anything without changing blades.

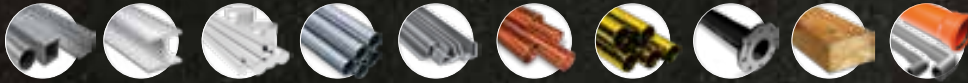

- Wood
- Plastic
- Pipe
- Tubing
- Channel

- Sheet Metal
- Mild Steel
- Tool Steel
- Angle Iron
- Stainless steel

- Copper
- Brass
- Aluminium
- Drill rods
- Beams

- H and I beams
- Solids
- Bundles

### EZ (EASY-CUT) TOOTHING

This patented design gives a very versatile blade, able to cut all common materials in addition to being highly resistant to tooth stripping. In combination with the multi-purpose tooth shape, it is ideal for small workshops cutting different sizes in different materials. Now you can spend more time cutting and less time changing saw blades!

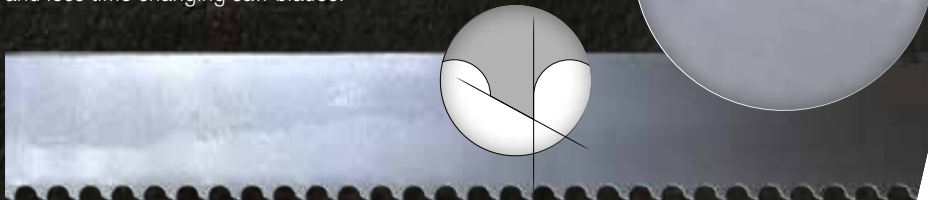

BI-METAL BLADE; HIGH-SPEED STEEL TOOTH TIPS COMBINED WITH FLEXIBLE ALLOY-STEEL BACKING MATERIAL



## 3857 EASY-CUT PORTABAND EASY-CUT PORTABAND



### FEATURES:

- The Easy-Cut is a new generation of General Purpose Bandsaw Blade
- The same blade will cut a much wider range of materials and shapes
- Specially designed for cutting ferrous, non-ferrous materials, solids, pipes, profiles or bundles
- When also cutting solid materials, we recommend (M) medium tothing for the best results
- New and unique, innovative tooth design, which allows a much wider operating range than a conventional tooth type
- Available lengths in MM: 1140 - 900 - 835 - 730 - 690
- Just choose the blade according to your work-piece size
- 3 blades are packed in each box

### ASSORTMENT:

3857-13-0.6-EZ-S-3P690	7314150345694	3	1	13	0,6	S	EZ	690	54,7
3857-13-0.6-EZ-S-3P730	7314150345700	3	1	13	0,6	S	EZ	730	54,7
3857-13-0.6-EZ-S-3P835	7314150345717	3	1	13	0,6	S	EZ	835	54,7
3857-13-0.6-EZ-S-3P900	7314150345724	3	1	13	0,6	S	EZ	900	54,7
3857-13-0.6-EZ-S-3P1140	7314150345731	3	1	13	0,6	S	EZ	1140	54,7

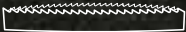
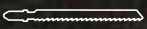
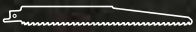

384





# ROTARY BURRS

384  
PRODUCTS

## PRODUCT INDEX

<i>CARBIDE ROTARY BURRS</i>	82
<i>CARBIDE ROTARY BURRS FOR ALUMINIUM</i>	90
<i>HIGH-SPEED STEEL ROTARY BURRS</i>	93

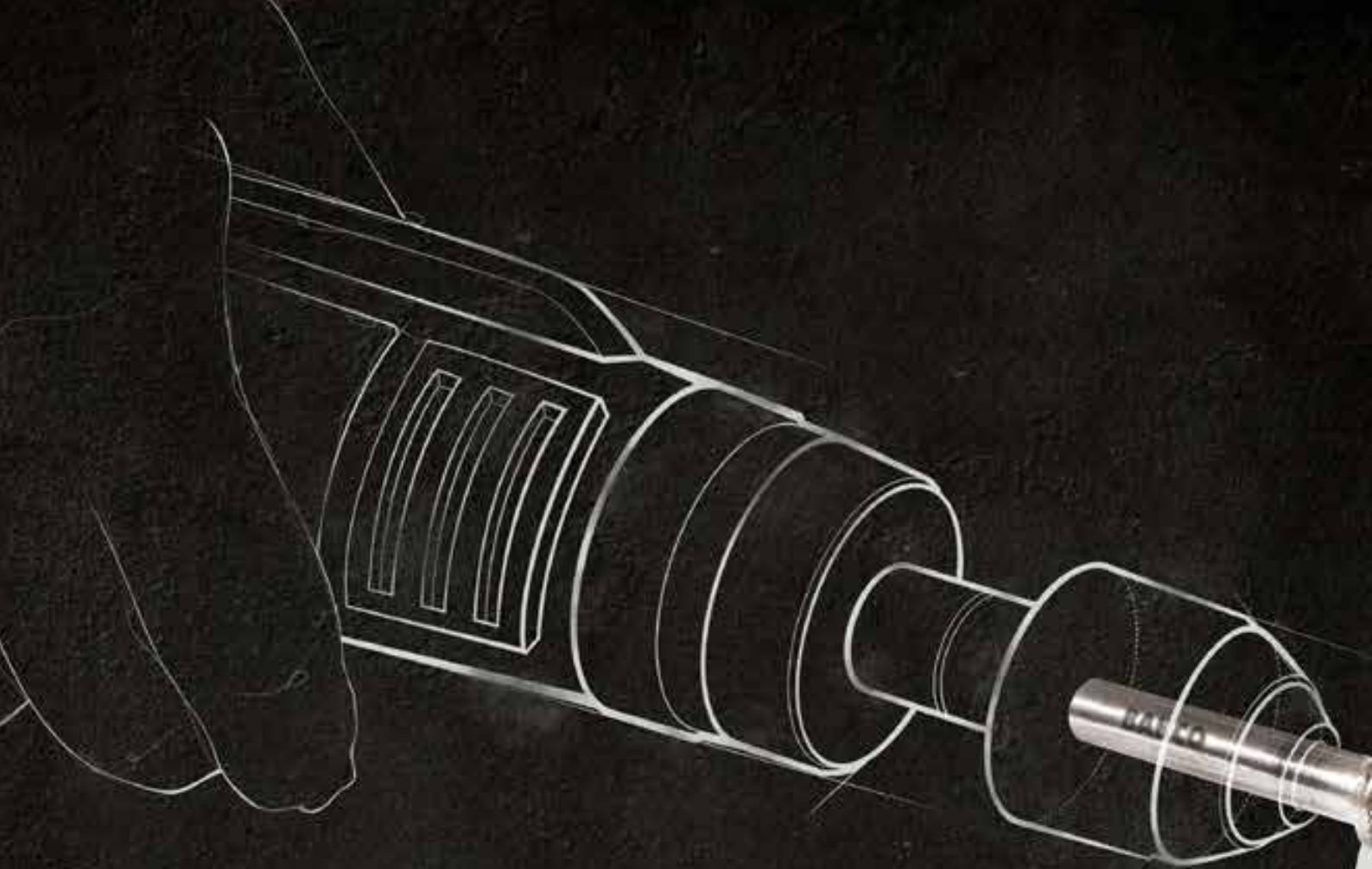

# **CONSISTENT HIGH PERFORMANCE**



**LONG-LIFE, PREMIUM QUALITY  
CARBIDE ROTARY BURRS**



**MADE IN OUR  
SWEDISH PLANT**



**WIDE RANGE COVERING  
ALMOST ALL APPLICATIONS**

# FULL OF POWER

**Bahco's range of rotary burrs represents the accumulated knowledge of more than 160 years of file production. Drawing on this experience, Bahco has developed and improved the design of this critical product, applying state-of-the-art manufacturing methods to its production. Rigorous quality control is built into the product, from ensuring the highest grade raw material to a finished product that delivers consistent performance.**

Our carbide rotary burrs are indispensable in industry sectors such as aviation, shipping, automotive and chemicals. Their application areas include machining cast iron, cast steel, carbon steel, alloy steel, stainless steel, hardened steel, copper and aluminium.

Our high-speed steel (HSS) rotary burrs are primarily used for deburring soft steel, bronze and brass. Our large range of shapes, sizes and fluting styles ensures that you'll find the right burr for your needs.

## FULL SUPPORT

### CUTTING SPEED RECOMMENDATIONS

To get maximum result out of each rotary burr, we recommend the following cutting speeds (RPM x 1.000).

#### CARBIDE

Head diameter	 FE	 18/8	 Cast iron	 CuZn	 Alu
3 mm:	40-80	50-90	50-90	50-100	50-100
6 mm:	25-60	30-60	30-60	30-70	30-70
8 mm:	20-45	25-50	25-50	25-50	25-50
10 mm:	17-40	20-40	20-40	20-40	20-40
12 mm:	15-30	17-30	17-30	17-35	17-35
16 mm:	12-25	15-25	15-25	15-30	15-30





#### HIGH SPEED STEEL

Head diameter	 18/8	 Cast iron	 CuZn	 Alu
3 mm:				
6 mm:	5-20	5-20	20-40	20-40
8 mm:				
10 mm:	3-10	3-10	10-30	10-30
12 mm:	1-10	1-10	10-30	10-30
16 mm:	1-8	1-8	10-25	10-25



# BURR SELECTION

384  
PRODUCTS

	<b>CARBIDE ROTARY BURRS</b>	<b>CARBIDE ROTARY BURRS FOR ALUMINIUM</b>	<b>HIGH-SPEED STEEL ROTARY BURRS</b>
<b>Range</b>	 3-16 mm (Head Diameter)	 3-16 mm (Head Diameter)	 6-12 mm (Head Diameter)
<b>Application</b>	 Made for various industrial applications, like aviation, marine, automotive or chemical.	 Specially designed for deburring aluminium and other soft materials.	 Primarily designed for machining soft steel, aluminium, bronze and brass.

## TYPE OF TOOTHING



**Fine**  
**F**

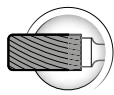

**Medium**  
**M**

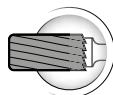

**Coarse**  
**C**

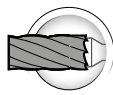

**Aluminium**  
**AL**

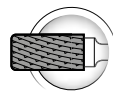

**X-cut**  
**X**

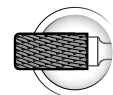

**Diamond-cut**  
**D**

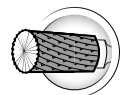

**End-cut**  
**E**



# FULL RANGE

## PRODUCT IDENTIFICATION SYSTEM

PRODUCT CODE

<b>E</b>	Type of cut	(E = End-Cut)
<b>03</b>	Burr shank diameter	(3 mm)
<b>F</b>	Type of tothing	(F = Fine)
<b>13</b>	Burr head length	(13 mm)
<b>03</b>	Burr head diameter	(3 mm)
<b>A</b>	Burr head shape	(A = Cylindrical)



**A = Cylindrical**



**C = Cylindrical round nose**



**D = Spherical**



**E = Oval**



**F = Tree round nose**



CARBIDE ROTARY BURRS

**Coarse**

A0313C03  
A0616C06  
A0820C06  
A1020C06  
A1225C06  
A1225C08  
A1625C06  
A1625C08

C0313C03  
C0616C06  
C0820C06  
C1020C06  
C1225C06  
C1225C08  
C1625C06  
C1625C08

D0303C03  
D0606C06  
D0807C06  
D1009C06  
D1211C06  
D1614C06  
D1614C08

E0308C03  
E0614C06  
E0816C06  
E1018C06  
E1222C06  
E1222C08  
E1625C06  
E1625C08

F0313C03  
F0612C04  
F0618C06  
F0820C06  
F1020C06  
F1225C06  
F1225C08  
F1625C06  
F1625C08

**Medium**

A0313M03  
A0313M03E  
A0313M03X  
A0313M03XE  
A0313M03XE-60  
A0313M03XE-80  
A0613M03X  
A0616M06  
A0616M06DE  
A0616M06E  
A0616M06X  
A0616M06XE  
A0820M06  
A0820M06E  
A0820M06X  
A0820M06XE  
A1020M06  
A1020M06E  
A1020M06X

A1020M06XE  
A1040M06X  
A1050M06X  
A1225M06  
A1225M06DE  
A1225M06E  
A1225M06X  
A1225M06XE  
A1225M08  
A1225M08E  
A1225M08X  
A1225M08XE  
A1625M06  
A1625M06X  
A1625M06XE  
A1625M08  
A1625M08E  
A1625M08X  
A1625M08XE

C0313M03  
C0313M03X  
C0613M03X  
C0616M03X  
C0616M06  
C0616M06D  
C0616M06X  
C0820M06  
C0820M06X  
C1020M06  
C1020M06X  
C1225M06  
C1225M06X  
C1225M08  
C1225M08X  
C1625M06  
C1625M06X  
C1625M08  
C1625M08X

D0303M03  
D0303M03X  
D0605M03X  
D0606M06  
D0606M06X  
D0807M06  
D0807M06X  
D1009M06  
D1009M06X  
D1211M06  
D1211M06X  
D1614M06  
D1614M06X  
D1614M08  
D1614M08X

E0308M03  
E0308M03X  
E0614M06  
E0816M06  
E0816M06X  
E1018M06  
E1018M06X  
E1222M06  
E1222M08  
E1222M08X  
E1625M06  
E1625M06X  
E1625M08  
E1625M08X

F0313M03  
F0313M03X  
F0612M04  
F0612M04X  
F0613M03X  
F0618M06  
F0618M06X  
F0820M06  
F0820M06X  
F1020M06  
F1020M06X  
F1225M06  
F1225M06X  
F1225M08  
F1225M08X  
F1625M06  
F1625M06X  
F1625M08  
F1625M08X

**Fine**

A0313F03  
A0313F03E  
A0616F06  
A0820F06  
A0820F06E  
A1020F06  
A1225F06  
A1225F06E  
A1225F08  
A1625F06  
A1625F08

C0313F03  
C0616F06  
C0820F06  
C1020F06  
C1225F06  
C1225F08  
C1625F06  
C1625F08

D0303F03  
D0606F06  
D0807F06  
D1009F06  
D1211F06  
D1211F06D  
D1614F06  
D1614F08

E0308F03  
E0614F06  
E0816F06  
E1018F06  
E1222F06  
E1222F08  
E1625F06  
E1625F08

F0313F03  
F0612F04  
F0618F06  
F0820F06  
F1020F06  
F1225F06  
F1225F08  
F1625F06  
F1625F08

CARBIDE ROTARY BURRS FOR ALUMINIUM

A0616AL06E  
A1225AL06E  
A1225AL08E

C0616AL06  
C1225AL06  
C1225AL08

D1211AL06  
D1211AL08

F0618AL06  
F1225AL06  
F1225AL08

HIGH-SPEED STEEL ROTARY BURRS

**Extra Coarse**

HSSG-A1225EC

HSSG-C1225EC

HSSG-D1211EC

HSSG-E1222EC

**Medium**

HSSG-A0616M  
HSSG-A1020M  
HSSG-A1225M

HSSG-C0616M  
HSSG-C1020M  
HSSG-C1225M

HSSG-D0606M  
HSSG-D0807M  
HSSG-D1009M  
HSSG-D1211M

HSSG-E0614M  
HSSG-E1222M

HSSG-F0618M  
HSSG-F1225M



## ADAPT TO EACH SITUATION FOR MAXIMUM RESULTS



**G = Arch pointed nose**



**H = Flame**



**J = 60° cone**



**K = 90° cone**



**L = Conical round nose**



**M = Conical pointed nose**



**N = Inverted cone**

G0313C03  
G0618C06  
G0820C06  
G1020C06  
G1225C06  
G1225C08  
G1625C06  
G1625C08

H1025C06  
H1635C06  
H1635C08

J0604C06  
J1010C06  
J1616C06  
J1616C08

K0602C06  
K1008C06  
K1210C06  
K1612C06  
K1612C08

L1020C06  
L1230C06  
L1630C06  
L1630C08

M0310C03  
M0618C06  
M1022C06  
M1227C06  
M1227C08  
M1630C06  
M1630C08

N0306C03  
N0607C06  
N1213C06  
N1613C06  
N1613C08

G0313M03  
G0313M03X  
G0618M03X  
G0618M06  
G0618M06X  
G0820M06  
G0820M06X  
G1020M06  
G1020M06X  
G1225M06  
G1225M06X  
G1225M08  
G1225M08X  
G1625M06  
G1625M06X  
G1625M08  
G1625M08X

H0613M03X  
H1025M06  
H1025M08  
H1025M06X  
H1232M06  
H1232M06X  
H1635M06X  
H1635M06  
H1635M08  
H1635M08X

J0604M06  
J1010M06  
J1212M06  
J1616M06  
J1616M08

K0602M06  
K1008M06  
K1210M06  
K1612M06  
K1612M08

L1020M06  
L1020M06X  
L1225M06  
L1225M06X  
L1230M06  
L1230M06X  
L1630M06  
L1630M06X  
L1630M08  
L1630M08X

M0310M03  
M0310M03X  
M0618M03X  
M0618M06  
M0618M06X  
M1022M06  
M1022M06D  
M1022M06X  
M1227M06  
M1227M06X  
M1227M08  
M1227M08X  
M1630M06  
M1630M06X  
M1630M08  
M1630M08X

N0306M03  
N0306M03E  
N0607M06  
N0607M06E  
N1213M06  
N1213M06E  
N1613M06  
N1613M06E  
N1613M06X  
N1613M08  
N1613M08E

G0313F03  
G0618F06  
G0820F06  
G1020F06  
G1225F06  
G1225F08  
G1625F06  
G1625F08

H1025F06  
H1635F06  
H1635F08

J0604F06  
J1010F06  
J1616F06  
J1616F08

K0602F06  
K1008F06  
K1210F06  
K1612F06  
K1612F08

L1020F06  
L1225F06  
L1230F06  
L1630F06  
L1630F08

M0310F03  
M0618F06  
M1022F06  
M1227F06  
M1227F08  
M1630F06  
M1630F08

N0306F03  
N0607F06  
N1213F06  
N1613F06  
N1613F08

L1230AL06  
L1230AL08

HSSG-G1225EC

HSSG-G0618M  
HSSG-G1220M  
HSSG-G1225M

HSSG-M0618M  
HSSG-M1227M

# CARBIDE ROTARY BURRS



351 PRODUCTS



LARGE RANGE OF  
ISO-STANDARD HEAD SHAPES



CONSISTENT CUTTING PERFORMANCE  
ALL AROUND THE BURR HEAD

STRONG SHANK CAN HANDLE SPEEDS  
FROM 1,000 UP TO 100,000 RPM

MADE OF POWERFUL  
LONG-LASTING CARBIDE

## A CARBIDE ROTARY BURRS WITH CYLINDRICAL HEAD

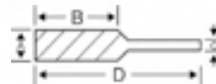

### FEATURES:

- DIN: ZYA
- Deburring of edges and plane surfaces

- Type of cut: F = Fine, M = Medium, C = Coarse
- Stock standard: X = yes

### ASSORTMENT

A0313C03	7311518023713	1	1	3	13	3	40	C	14	x	10	
A0313F03	7311518023690	1	1	3	13	3	40	F	18	x	10	
A0313F03E	7311518212780	1	1	3	13	3	40	F*	18		10	
A0313M03	7311518023706	1	1	3	13	3	40	M	14	x	10	
A0313M03E	7311518192150	1	1	3	13	3	40	M*	14		10	
A0313M03X	7311518182038	1	1	3	13	3	40	M	14,7	x	10	
A0313M03XE	7311518181475	1	1	3	13	3	40	M XE	14,7	x	10	
A0313M03XE-60	7311518184513	1	1	3	13	3	60	M*	14,7		15	
A0313M03XE-80	7311518201357	1	1	3	13	3	80	M	14,7	x	15	
A0613M03X	7311518197872	1	1	6	13	3	48	M X	16,8	x	15	
A0616C06	7311518023782	1	1	6	16	6	50	C	10	x	20	
A0616F06	7311518023720	1	1	6	16	6	50	F	24	x	20	
A0616M06	7311518023737	1	1	6	16	6	50	M	16	x	20	
A0616M06DE	7311518212629	1	1	6	16	6	50	M*	16,16		20	
A0616M06E	7311518023751	1	1	6	16	6	50	M	18	x	20	
A0616M06X	7311518023768	1	1	6	16	6	50	M	16,8	x	20	
A0616M06XE	7311518181468	1	1	6	16	6	50	M	16,8	x	20	
A0820F06	7311518023799	1	1	8	20	6	60	F	28		30	

A0820F06E	7311518212803	1	1	8	20	6	60	F*	28		30	
A0820M06	7311518023805	1	1	8	20	6	60	M	18	x	30	
A0820M06E	7311518023829	1	1	8	20	6	60	M*	18		30	
A0820M06X	7311518023836	1	1	8	20	6	60	M	18,9	x	30	
A0820M06XE	7311518181994	1	1	8	20	6	60	M	18,9	x	30	
A0820C06	7311518023850	1	1	8	20	6	60	C*	12		30	
A1020F06	7311518023867	1	1	10	20	6	60	F*	32		30	
A1020M06	7311518023874	1	1	10	20	6	60	M	20	x	30	
A1020M06E	7311518023898	1	1	10	20	6	60	M*	20		30	
A1020M06X	7311518023904	1	1	10	20	6	60	M	20,10	x	30	
A1020M06XE	7311518182007	1	1	10	20	6	60	M	20,10	x	30	
A1020C06	7311518023928	1	1	10	20	6	60	C*	14		30	
A1040M06X	7311518233129	1	1	10	40	6	60	x*	20,10		55	
A1050M06X	7311518233136	1	1	10	50	6	60	x*	20,10		65	
A1225F06	7311518023935	1	1	12	25	6	65	F*	36		50	
A1225F06E	7311518212810	1	1	12	25	6	65	F*	36		50	
A1225M06	7311518023942	1	1	12	25	6	65	M	24	x	50	
A1225M06DE	7311518212636	1	1	12	25	6	65	M*	24,24		50	

					A	B	C	D				
A1225M06E		7311518023966	1	1	12	25	6	65	M*	24		50
A1225M06X		7311518023973	1	1	12	25	6	65	M	24, 12	x	50
A1225M06XE		7311518182014	1	1	12	25	6	65	M	24, 12	x	50
A1225C06		7311518023997	1	1	12	25	6	65	C	16	x	50
A1225F08		7311518024000	1	1	12	25	8	65	F*	36		55
A1225M08		7311518100506	1	1	12	25	8	65	M	24	x	55
A1225M08E		7311518100520	1	1	12	25	8	65	M*	24		55
A1225M08X		7311518187989	1	1	12	25	8	65	M*	24		55
A1225M08XE		7311518192174	1	1	12	25	8	65	M*	24, 12		55
A1225C08		7311518100544	1	1	12	25	8	65	C*	16		55
A1625F06		7311518192198	1	1	16	25	6	65	F*	40		70

					A	B	C	D				
A1625M06		7311518192181	1	1	16	25	6	65	M*	28		70
A1625M06X		7311518187361	1	1	16	25	6	65	M	28	x	70
A1625M06XE		7311518187354	1	1	16	25	6	65	M*	28, 14		70
A1625C06		7311518192204	1	1	16	25	6	65	C*	18		70
A1625F08		7311518100551	1	1	16	25	8	65	F*	40		70
A1625M08		7311518100568	1	1	16	25	8	65	M	28	x	70
A1625M08E		7311518100582	1	1	16	25	8	65	M*	28		70
A1625M08X		7311518100599	1	1	16	25	8	65	M	28, 14	x	70
A1625M08XE		7311518182021	1	1	16	25	8	65	M	28, 14	x	70
A1625C08		7311518100612	1	1	16	25	8	65	C*	18		70

## C CARBIDE ROTARY BURRS WITH CYLINDRICAL ROUND NOSE HEAD

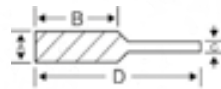

### FEATURES:

- DIN: WRC
- Deburring of surfaces with round edges and surfaces

- Type of cut: F = Fine, M = Medium, C = Coarse
- Stock standard: X = yes

### ASSORTMENT

					A	B	C	D				
C0313C03		7311518100643	1	1	3	13	3	40	C	10	x	10
C0313F03		7311518100629	1	1	3	13	3	40	F	18	x	10
C0313M03		7311518100636	1	1	3	13	3	40	M	14	x	10
C0313M03X		7311518182045	1	1	3	13	3	40	M	14, 7	x	10
C0613M03X		7311518197889	1	1	6	13	3	48	M	16, 8	x	15
C0616C06		7311518100698	1	1	6	16	6	50	C	10	x	20
C0616F06		7311518100650	1	1	6	16	6	50	F	24	x	20
C0616M03X		7311518204679	1	1	6	16	3	53	M	16, 8	x	20
C0616M06		7311518100667	1	1	6	16	6	50	M	16	x	20
C0616M06D		7311518215262	1	1	6	16	6	50	M*	16, 16		20
C0616M06X		7311518100681	1	1	6	16	6	50	M	16, 8	x	20
C0820F06		7311518100704	1	1	8	20	6	60	F	32	x	30
C0820M06		7311518100711	1	1	8	20	6	60	M	18	x	30
C0820M06X		7311518100735	1	1	8	20	6	60	M	18, 9	x	30
C0820C06		7311518100742	1	1	8	20	6	60	C*	12		30
C1020F06		7311518100759	1	1	10	20	6	60	F*	32		30
C1020M06		7311518100766	1	1	10	20	6	60	M	20	x	30
C1020M06X		7311518100780	1	1	10	20	6	60	M	20, 10	x	30

					A	B	C	D				
C1020C06		7311518100797	1	1	10	20	6	60	C	14	x	30
C1225F06		7311518100803	1	1	12	25	6	65	F	32	x	50
C1225M06		7311518100810	1	1	12	25	6	65	M	24	x	50
C1225M06X		7311518100834	1	1	12	25	6	65	M	24, 12	x	50
C1225C06		7311518100841	1	1	12	25	6	65	C	16	x	50
C1225F08		7311518100858	1	1	12	25	8	65	F*	36		55
C1225M08		7311518100865	1	1	12	25	8	65	M	24	x	55
C1225M08X		7311518187996	1	1	12	25	8	65	M	24, 12	x	55
C1225C08		7311518100889	1	1	12	25	8	65	C*	16		55
C1625F06		7311518192259	1	1	16	25	6	65	F*	40		70
C1625M06		7311518192266	1	1	16	25	6	65	M	28	x	70
C1625M06X		7311518187378	1	1	16	25	6	65	M	28, 14	x	70
C1625C06		7311518192273	1	1	16	25	6	65	C*	18		70
C1625F08		7311518100896	1	1	16	25	8	65	F*	40		70
C1625M08		7311518100902	1	1	16	25	8	65	M	28	x	70
C1625M08X		7311518100926	1	1	16	25	8	65	M	28, 14	x	70
C1625C08		7311518100933	1	1	16	25	8	65	C*	18		70

**D**

**CARBIDE ROTARY BURRS WITH SPHERICAL HEAD**

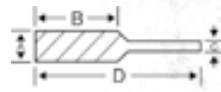

**FEATURES:**

- DIN: KUD
- Deburring of welds and holes. To make oil canals in narrow places

- Type of cut: F = Fine, M = Medium, C = Coarse
- Stock standard: X = yes

**ASSORTMENT**

		X	A	B	C	D					
D0303F03	7311518100940	1	1	3	3	3	40	F	18	x	10
D0303M03	7311518100957	1	1	3	3	3	40	M	14	x	10
D0303M03X	7311518182052	1	1	3	3	3	40	M	14,7	x	10
D0303C03	7311518100964	1	1	3	3	3	40	C*	10		10
D0605M03X	7311518197896	1	1	6	5	3	40	M	16,8	x	15
D0606F06	7311518100971	1	1	6	6	6	50	F*	24		20
D0606M06	7311518100988	1	1	6	6	6	50	M	16	x	20
D0606M06X	7311518101008	1	1	6	6	6	50	M	16,8	x	20
D0606C06	7311518043872	1	1	6	6	6	50	C	12	x	20
D0807F06	7311518043889	1	1	8	7	6	47	F*	28		20
D0807M06	7311518043896	1	1	8	7	6	47	M	18	x	20
D0807M06X	7311518043919	1	1	8	7	6	47	M	18,9	x	20
D0807C06	7311518043933	1	1	8	7	6	47	C*	14		20
D1009F06	7311518043926	1	1	10	9	6	49	F*	32		20
D1009M06	7311518035280	1	1	10	9	6	49	M	20	x	20

		X	A	B	C	D					
D1009M06X	7311518035297	1	1	10	9	6	49	M	20,10	x	20
D1009C06	7311518035310	1	1	10	9	6	49	C	14	x	20
D1211F06	7311518035327	1	1	12	11	6	51	F	36	x	30
D1211F06D	7311518266424	1	1	12	11	6	51	D*	36		30
D1211M06	7311518035334	1	1	12	11	6	51	M	24	x	30
D1211M06X	7311518035358	1	1	12	11	6	51	M	24,12	x	30
D1211C06	7311518035365	1	1	12	11	6	51	C	16	x	30
D1614F06	7311518192334	1	1	16	14	6	54	F*	40		50
D1614M06	7311518192327	1	1	16	14	6	54	M	28	x	50
D1614M06X	7311518187385	1	1	16	14	6	54	M	28,14	x	50
D1614C06	7311518192341	1	1	16	14	6	54	C*	18		50
D1614F08	7311518035372	1	1	16	14	8	54	F*	40		50
D1614M08	7311518035389	1	1	16	14	8	54	M*	28		50
D1614M08X	7311518035402	1	1	16	14	8	54	M*	28,14		50
D1614C08	7311518035419	1	1	16	14	8	65	C*	18		50

**E**

**CARBIDE ROTARY BURRS WITH OVAL HEAD**

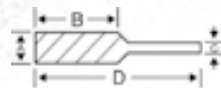

**FEATURES:**

- DIN: TRE
- Shaping and deburring in, for example, cylinder blocks and tools with complicated forms

- Type of cut: F = Fine, M = Medium, C = Coarse
- Stock standard: X = yes

**ASSORTMENT**

		X	A	B	C	D					
E0308F03	7311518035426	1	1	3	8	3	40	F*	18		10
E0308M03	7311518035433	1	1	3	8	3	40	M	14	x	10
E0308M03X	7311518192372	1	1	3	8	3	40	M*	14,7		10
E0308C03	7311518035440	1	1	3	8	3	40	C*	10		10
E0614F06	7311518035457	1	1	6	14	6	50	F*	24		20
E0614M06	7311518035464	1	1	6	14	6	50	M	16	x	20
E0614C06	7311518035495	1	1	6	14	6	50	C*	12		20
E0816F06	7311518035501	1	1	8	16	6	60	F*	24		30
E0816M06	7311518035518	1	1	8	16	6	60	M	18	x	30
E0816M06X	7311518035532	1	1	8	16	6	60	M	18,9	x	30

		X	A	B	C	D					
E0816C06	7311518035549	1	1	8	16	6	60	C*	12		30
E1018F06	7311518035556	1	1	10	18	6	60	F*	32		30
E1018M06	7311518035563	1	1	10	18	6	60	M	20	x	30
E1018M06X	7311518035587	1	1	10	18	6	60	M	20,10	x	30
E1018C06	7311518035594	1	1	10	18	6	60	C*	14		30
E1222F06	7311518035600	1	1	12	22	6	60	F*	36		40
E1222M06	7311518035617	1	1	12	25	6	65	M	24	x	40
E1222M06X	7311518035631	1	1	12	22	6	65	M	24,12	x	40
E1222C06	7311518035648	1	1	12	22	6	60	C*	16		40
E1222F08	7311518035655	1	1	12	22	8	65	F*	36		40

					A	B	C	D				
E1222M08	7311518172558	1	1	12	22	8	65	M*	24		40	
E1222M08X	7311518199302	1	1	12	22	8	65	M*	24, 12		40	
E1222C08	7311518035686	1	1	12	22	8	65	C*	16		40	
E1625F06	7311518192457	1	1	16	25	6	65	F*	40		70	
E1625M06	7311518192440	1	1	16	25	6	65	M	28	x	70	
E1625M06X	7311518187392	1	1	16	25	6	65	M	28, 14	x	70	

					A	B	C	D				
E1625C06	7311518192464	1	1	16	25	6	65	C*	18		70	
E1625F08	7311518035693	1	1	16	25	8	65	F*	40		70	
E1625M08	7311518035709	1	1	16	25	8	65	M*	28		70	
E1625M08X	7311518035723	1	1	16	25	8	65	M	28, 14	x	70	
E1625C08	7311518035730	1	1	16	25	8	65	C*	16		70	

## F

# CARBIDE ROTARY BURRS WITH ROUND NOSE TREE HEAD

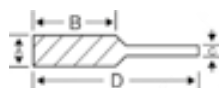

### FEATURES:

- DIN: TRE
- Shaping and deburring in, for example, cylinder blocks and tools with complicated forms
- Type of cut: F = Fine, M = Medium, C = Coarse
- Stock standard: X = yes

### ASSORTMENT

					A	B	C	D				
F0313F03	7311518035747	1	1	3	13	3	40	F	24	x	15	
F0313M03	7311518035754	1	1	3	13	3	40	M	14	x	15	
F0313M03X	7311518192495	1	1	3	13	3	40	M	14, 7	x	15	
F0313C03	7311518035761	1	1	3	13	3	40	C*	10		15	
F0612F04	7311518192518	1	1	6	12	4	45	F*	24		10	
F0612M04	7311518035778	1	1	6	12	4	45	M*	16		10	
F0612M04X	7311518188474	1	1	6	12	4	45	M*	16, 8		10	
F0612C04	7311518192525	1	1	6	12	4	45	C*	10		10	
F0613M03X	7311518196608	1	1	6	13	3	48	M	16, 8	x	10	
F0618F06	7311518035785	1	1	6	18	6	50	F*	24		20	
F0618M06	7311518035792	1	1	6	18	6	50	M	16	x	20	
F0618M06X	7311518035815	1	1	6	18	6	50	M	16, 8	x	20	
F0618C06	7311518035822	1	1	6	18	6	50	C	10	x	20	
F0820F06	7311518035846	1	1	8	20	6	60	F*	28		30	
F0820M06	7311518035839	1	1	8	20	6	60	M	18	x	30	
F0820M06X	7311518035860	1	1	8	20	6	60	M	18, 9	x	30	
F0820C06	7311518035877	1	1	8	20	6	60	C*	12		30	
F1020F06	7311518035884	1	1	10	20	6	60	F*	32		30	
F1020M06	7311518035891	1	1	10	20	6	60	M	20	x	30	

					A	B	C	D				
F1020M06X	7311518035914	1	1	10	20	6	60	M	20, 10	x	30	
F1020C06	7311518035921	1	1	10	20	6	60	C*	14		30	
F1225F06	7311518035938	1	1	12	25	6	65	F	36	x	40	
F1225M06	7311518035945	1	1	12	25	6	65	M	24	x	40	
F1225M06X	7311518036003	1	1	12	25	6	65	M	24, 12	x	40	
F1225C06	7311518035969	1	1	12	25	6	65	C	16	x	40	
F1225F08	7311518035976	1	1	12	25	8	65	F*	36		45	
F1225M08	7311518035983	1	1	12	25	8	65	M	24	x	45	
F1225M08X	7311518192563	1	1	12	25	8	65	M	24, 12	x	45	
F1225C08	7311518036010	1	1	12	25	8	65	C*	16		45	
F1625F06	7311518192587	1	1	16	25	6	65	F*	40		70	
F1625M06	7311518192570	1	1	16	25	6	65	M	28	x	70	
F1625M06X	7311518187408	1	1	16	25	6	65	M	28, 14	x	70	
F1625C06	7311518192594	1	1	16	25	6	65	C*	18		70	
F1625F08	7311518036027	1	1	16	25	8	65	F*	40		70	
F1625M08	7311518036034	1	1	16	25	8	65	M*	28		70	
F1625M08X	7311518036058	1	1	16	25	8	65	M*	28, 14		70	
F1625C08	7311518036065	1	1	16	25	8	65	C*	18		70	

## G

# CARBIDE ROTARY BURRS WITH POINTED TREE HEAD

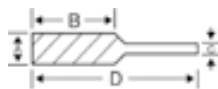

### FEATURES:

- DIN: SPG
- Is useful in confined spaces due to the pointed nose
- Type of cut: F = Fine, M = Medium, C = Coarse
- Stock standard: X = yes

### ASSORTMENT

			X	A	B	C	D					
G0313F03	7311518036072	1	1	3	13	3	40	F	18	x	10	
G0313M03	7311518036089	1	1	3	13	3	40	M	14	x	10	
G0313M03X	7311518182069	1	1	3	13	3	40	M	14,7	x	10	
G0313C03	7311518036096	1	1	3	13	3	40	C	12	x	10	
G0613M03X	7311518196592	1	1	6	13	3	48	M	16,8	x	15	
G0618F06	7311518036102	1	1	6	18	6	50	F	24	x	20	
G0618M06	7311518036119	1	1	6	18	6	50	M	16	x	20	
G0618M06X	7311518036133	1	1	6	18	6	50	M	16,8	x	20	
G0618C06	7311518036140	1	1	6	18	6	50	C	10	x	20	
G0820F06	7311518036157	1	1	8	20	6	60	F*	28		30	
G0820M06	7311518036164	1	1	8	20	6	60	M	18	x	30	
G0820M06X	7311518036188	1	1	8	20	6	60	M	18,9	x	30	
G0820C06	7311518172572	1	1	8	20	6	60	C*	12		30	
G1020F06	7311518036201	1	1	10	20	6	60	F*	32		30	
G1020M06	7311518036218	1	1	10	20	6	60	M	20	x	30	
G1020M06X	7311518036232	1	1	10	20	6	60	M	20,10	x	30	
G1020C06	7311518036249	1	1	10	20	6	60	C*	14		30	

			X	A	B	C	D					
G1225F06	7311518036300	1	1	12	25	6	65	F	36	x	40	
G1225M06	7311518036317	1	1	12	25	6	65	M	24	x	40	
G1225M06X	7311518036331	1	1	12	25	6	65	M	24,12	x	40	
G1225C06	7311518036348	1	1	12	25	6	65	C	16	x	40	
G1225F08	7311518036355	1	1	12	25	8	65	F*	36		40	
G1225M08	7311518036362	1	1	12	25	8	65	M	24	x	40	
G1225M08X	7311518188009	1	1	12	25	8	65	M	24,12	x	40	
G1225C08	7311518036386	1	1	12	25	8	65	C*	16		40	
G1625F06	7311518192655	1	1	16	25	6	65	F*	40		70	
G1625M06	7311518192648	1	1	16	25	6	65	M	28	x	70	
G1625M06X	7311518187415	1	1	16	25	6	65	M	28,14	x	70	
G1625C06	7311518192662	1	1	16	25	6	65	C*	18		70	
G1625F08	7311518036393	1	1	16	25	8	65	F*	40		70	
G1625M08	7311518036409	1	1	16	25	8	65	M*	28		70	
G1625M08X	7311518036423	1	1	16	25	8	65	M	28,14	x	70	
G1625C08	7311518036430	1	1	16	25	8	65	C*	18		70	

## H

# CARBIDE ROTARY BURRS WITH FLAME HEAD

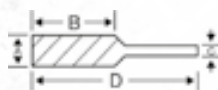

### FEATURES:

- DIN: FLH
- Deburring of large curved surfaces and inside tubes
- Type of cut: F = Fine, M = Medium, C = Coarse
- Stock standard: X = yes

### ASSORTMENT

			X	A	B	C	D					
H0613M03X	7311518196615	1	1	6	13	3	48	M	16,8	x	20	
H1025F06	7311518182335	1	1	10	25	6	65	F*	32		30	
H1025M06	7311518182304	1	1	10	25	6	65	M	20	x	30	
H1025M08	7311518273439	1	1	10	25	8	65	M*	20		42	
H1025M06X	7311518182311	1	1	10	25	6	65	M	20,10	x	30	
H1025C06	7311518182328	1	1	10	25	6	65	C*	14		30	
H1232M06	7311518182076	1	1	12	32	6	72	M	24	x	40	
H1232M06X	7311518181758	1	1	12	32	6	72	M	24,12	x	40	

			X	A	B	C	D					
H1635F06	7311518192747	1	1	16	35	6	75	F*	40		70	
H1635M06X	7311518187422	1	1	16	35	6	75	M	28,14	x	70	
H1635M06	7311518192730	1	1	16	35	6	75	M*	28		70	
H1635C06	7311518192754	1	1	16	35	6	75	C*	18		70	
H1635F08	7311518192778	1	1	16	35	8	75	F*	40		70	
H1635M08	7311518182083	1	1	16	35	8	75	M*	28		70	
H1635M08X	7311518182090	1	1	16	35	8	75	M*	28,14		70	
H1635C08	7311518192785	1	1	16	35	8	75	C*	18		70	

J

## CARBIDE ROTARY BURRS WITH 60° CONE HEAD

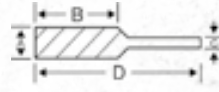

### FEATURES:

- DIN: KSJ
- Smoothing edges in 30°
- Type of cut: F = Fine, M = Medium, C = Coarse
- Stock standard: X = yes

### ASSORTMENT

		X	A	B	C	D					
J0604F06	7311518036492	1	1	6	4	6	55	F*	24		20
J0604M06	7311518036508	1	1	6	4	6	55	M	16	x	20
J0604C06	7311518036515	1	1	6	4	6	55	C*	10		20
J1010F06	7311518036522	1	1	10	10	6	50	F*	30		25
J1010M06	7311518172473	1	1	10	10	6	50	M	21	x	25
J1010C06	7311518036553	1	1	10	10	6	50	C*	15		25
J1212M06	7311518036577	1	1	12	12	6	52	M	24	x	30

		X	A	B	C	D					
J1616F06	7311518192815	1	1	16	16	6	56	F*	39		40
J1616M06	7311518187439	1	1	16	16	6	56	M	27	x	40
J1616C06	7311518192822	1	1	16	16	6	56	C*	21		40
J1616F08	7311518036607	1	1	16	16	8	56	F*	39		40
J1616M08	7311518036614	1	1	16	16	8	56	M*	27		40
J1616C08	7311518036638	1	1	16	16	8	56	C*	21		40

K

## CARBIDE ROTARY BURRS WITH 90° CONE HEAD

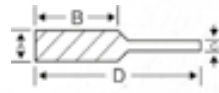

### FEATURES:

- DIN: KSK
- Smoothing edges at 45°
- Type of cut: F = Fine, M = Medium, C = Coarse
- Stock standard: X = yes

### ASSORTMENT

		X	A	B	C	D					
K0602F06	7311518036645	1	1	6	2	6	55	F*	24		20
K0602M06	7311518036652	1	1	6	2	6	55	M	16	x	20
K0602C06	7311518036669	1	1	6	2	6	55	C*	10		20
K1008F06	7311518036676	1	1	10	8	6	48	F*	30		30
K1008M06	7311518036683	1	1	10	8	6	48	M	21	x	30
K1008C06	7311518036706	1	1	10	8	6	48	C*	15		30
K1210F06	7311518036713	1	1	12	10	6	50	F*	36		30
K1210M06	7311518036720	1	1	12	10	6	50	M	24	x	30

		X	A	B	C	D					
K1210C06	7311518036744	1	1	12	10	6	50	C*	18		30
K1612F06	7311518193966	1	1	16	12	6	52	F*	39		40
K1612M06	7311518193959	1	1	16	12	6	52	M*	27		40
K1612C06	7311518193973	1	1	16	12	6	52	C*	21		40
K1612M08	7311518036768	1	1	16	12	8	52	M	27	x	40
K1612F08	7311518036751	1	1	16	12	8	52	F*	39		40
K1612C08	7311518036782	1	1	16	12	8	52	C*	21		40

## L CARBIDE ROTARY BURRS WITH ROUND NOSE CONICAL HEAD

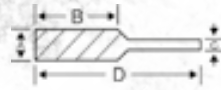

### FEATURES:

- DIN: KEL
- Long burr head for work in confined spaces with round corners

- Type of cut: F = Fine, M = Medium, C = Coarse
- Stock standard: X = yes

### ASSORTMENT

					A	B	C	D				
L1020F06	7311518182106	1	1	10	20	6	60	F*	32			30
L1020M06	7311518133665	1	1	10	20	6	60	M	20	x		30
L1020M06X	7311518136369	1	1	10	20	6	60	M	20,10	x		30
L1020C06	7311518182113	1	1	10	20	6	60	C*	14			30
L1225F06	7311518192860	1	1	12	25	6	65	F*	36			30
L1225M06	7311518132774	1	1	12	25	6	65	M	24	x		30
L1225M06X	7311518136857	1	1	12	25	6	65	M	24,12	x		30
L1230F06	7311518182137	1	1	12	30	6	70	F*	36			50
L1230M06	7311518182168	1	1	12	30	6	70	M	24	x		50
L1230M06X	7311518182175	1	1	12	30	6	70	M	24	x		50

					A	B	C	D				
L1230C06	7311518182120	1	1	12	30	6	70	C*	16			50
L1630F06	7311518192921	1	1	16	30	6	70	F*	40			70
L1630M06	7311518192914	1	1	16	30	6	70	M*	28			70
L1630M06X	7311518187446	1	1	16	30	6	70	M	28,14	x		70
L1630C06	7311518192938	1	1	16	30	6	70	C*	18			70
L1630M08	7311518182205	1	1	16	30	8	70	M	28	x		70
L1630M08X	7311518136833	1	1	16	30	8	70	M	28,14	x		70
L1630F08	7311518182151	1	1	16	30	8	70	F*	40			70
L1630C08	7311518182144	1	1	16	30	8	70	C*	18			70

## M CARBIDE ROTARY BURRS WITH POINTED NOSE CONICAL HEAD

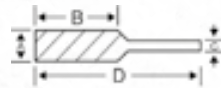

### FEATURES:

- DIN: SKM
- Deburring holes and in confined spaces

- Type of cut: F = Fine, M = Medium, C = Coarse
- Stock standard: X = yes

### ASSORTMENT

					A	B	C	D				
M0310F03	7311518036799	1	1	3	10	3	40	F	18	x		10
M0310M03	7311518036805	1	1	3	10	3	40	M	14	x		10
M0310M03X	7311518187063	1	1	3	10	3	40	M	14,7	x		10
M0310C03	7311518036812	1	1	3	10	3	40	C*	10			10
M0613M03X	7311518196622	1	1	6	13	3	48	M	16,8	x		15
M0618F06	7311518036829	1	1	6	18	6	50	F	30	x		20
M0618M06	7311518036836	1	1	6	18	6	50	M	16	x		20
M0618M06X	7311518036850	1	1	6	18	6	50	M	16,8	x		20
M0618C06	7311518036867	1	1	6	18	6	50	C	10	x		20
M1022F06	7311518036874	1	1	10	20	6	60	F*	36			30
M1022M06	7311518036881	1	1	10	20	6	60	M	21	x		30
M1022M06D	7311518210762	1	1	10	20	6	60	M*	21,21			30
M1022M06X	7311518036904	1	1	10	20	6	60	M	21,11	x		30
M1022C06	7311518036911	1	1	10	20	6	60	C*	18			30
M1227F06	7311518036935	1	1	12	25	6	65	F*	36			40

					A	B	C	D				
M1227M06	7311518036928	1	1	12	25	6	65	M	24	x		40
M1227M06X	7311518036959	1	1	12	25	6	65	M	24,12	x		40
M1227C06	7311518036966	1	1	12	25	6	65	C*	18			40
M1227F08	7311518036973	1	1	12	25	8	65	F*	36			40
M1227M08	7311518036980	1	1	12	25	8	65	M*	24			40
M1227M08X	7311518192990	1	1	12	25	8	65	M*	24,12			40
M1227C08	7311518192983	1	1	12	25	8	65	C*	18			40
M1630F06	7311518193027	1	1	16	30	6	70	F*	39			70
M1630M06	7311518193010	1	1	16	30	6	70	M	27	x		70
M1630M06X	7311518187453	1	1	16	30	6	70	M	27,14	x		70
M1630C06	7311518193034	1	1	16	30	6	70	C*	21			70
M1630F08	7311518037055	1	1	16	30	8	70	F*	39			70
M1630M08	7311518037062	1	1	16	30	8	70	M	27	x		70
M1630M08X	7311518037086	1	1	16	30	8	70	M	27,14	x		70
M1630C08	7311518037093	1	1	16	30	8	70	C*	21			70



N

## CARBIDE ROTARY BURRS WITH INVERTED CONE HEAD

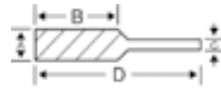

### FEATURES:

- DIN: WKN
- Deburring holes and in confined spaces
- Type of cut: F = Fine, M = Medium, C = Coarse
- Stock standard: X = yes

### ASSORTMENT

		X		A	B	C	D				
N0306F03	7311518193058	1	1	3	6	3	40	F*	18		10
N0306M03	7311518182212	1	1	3	6	3	40	M	14	x	10
N0306M03E	7311518182229	1	1	3	6	3	40	M*	14		10
N0306C03	7311518193065	1	1	3	6	3	40	C*	10		10
N0607F06	7311518193072	1	1	6	7	6	50	F*	24		20
N0607M06	7311518182236	1	1	6	7	6	50	M*	16		20
N0607M06E	7311518182243	1	1	6	7	6	50	M*	24		20
N0607C06	7311518193089	1	1	6	7	6	50	C*	10		20
N1213F06	7311518193096	1	1	12	13	6	53	F*	36		30
N1213M06	7311518134570	1	1	12	13	6	53	M	24	x	30
N1213M06E	7311518182250	1	1	12	13	6	53	M*	24		30

		X		A	B	C	D				
N1213M06X	7311518237172	1	1	12	13	6	53	x	24	x	30
N1213C06	7311518193102	1	1	12	13	6	53	C*	16		30
N1613F06	7311518193126	1	1	16	13	6	53	F*	40		50
N1613M06	7311518136000	1	1	16	13	6	53	M*	28		50
N1613M06E	7311518193119	1	1	16	13	6	53	M*	28		50
N1613M06X	7311518204525	1	1	16	13	6	53	M*	28, 14		50
N1613C06	7311518193133	1	1	16	13	6	53	C*	18		50
N1613F08	7311518193140	1	1	16	13	8	53	F*	40		50
N1613M08	7311518182267	1	1	16	13	8	53	M	28	x	50
N1613M08E	7311518182274	1	1	16	13	8	53	M*	28		50
N1613C08	7311518193157	1	1	16	13	8	53	C	18		50

# CARBIDE ROTARY BURRS FOR ALUMINIUM



13 PRODUCTS



CONSISTENT CUTTING PERFORMANCE  
ALL AROUND THE BURR HEAD

STRONG SHANK CAN HANDLE SPEEDS  
FROM 1,000 UP TO 100,000 RPM

MADE OF POWERFUL  
LONG-LASTING CARBIDE

DESIGNED FOR ALUMINIUM  
AND OTHER SOFT MATERIALS

A-AL

## CARBIDE ROTARY BURRS WITH CYLINDRICAL HEAD FOR ALUMINIUM

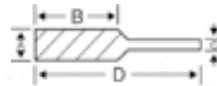

### FEATURES:

- Deburring aluminium and other soft materials
- Use wax to avoid chip build-up
- Special cutting edge suitable for soft materials
- Type of cut: AL = AL-cut
- Stock standard: X = yes

### ASSORTMENT

				A	B	C	D							
A0616AL06E	7311518181802	1	1	6	16	6	51	AL	5	x	20			
A1225AL06E	7311518187620	1	1	12	25	6	70	AL	6	x	50			

				A	B	C	D							
A1225AL08E	7311518181819	1	1	12	25	8	76	AL	6	x	50			

## C-AL

# CARBIDE ROTARY BURRS WITH ROUND NOSE CYLINDRICAL HEAD FOR ALUMINIUM

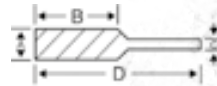

### FEATURES:

- Deburring aluminium and other soft materials
- Use wax to avoid chip build-up
- Special cutting edge suitable for soft materials
- Type of cut: AL = AL-cut
- Stock standard: X = yes

### ASSORTMENT

					A	B	C	D				
CO616AL06	7311518181826	1	1	6	16	6	51	AL	5	x	20	
C1225AL06	7311518187637	1	1	12	25	6	70	AL	6	x	50	

					A	B	C	D				
C1225AL08	7311518181833	1	1	12	25	8	76	AL	6	x	50	

## D-AL

# CARBIDE ROTARY BURRS WITH SPHERICAL HEAD FOR ALUMINIUM

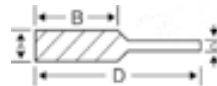

### FEATURES:

- Deburring aluminium and other soft materials
- Use wax to avoid chip build-up
- Special cutting edge suitable for soft materials
- Type of cut: AL = AL-cut
- Stock standard: X = yes

### ASSORTMENT

					A	B	C	D				
D1211AL06	7311518187644	1	1	12	11	6	56	AL	6	x	50	

					A	B	C	D				
D1211AL08	7311518181840	1	1	12	11	8	62	AL*	6		60	

## F-AL

# CARBIDE ROTARY BURRS WITH ROUND NOSE TREE HEAD FOR ALUMINIUM

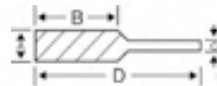

### FEATURES:

- Deburring aluminium and other soft materials
- Use wax to avoid chip build-up
- Special cutting edge for soft materials
- Type of cut: AL = AL-cut
- Stock standard: X = yes

### ASSORTMENT

					A	B	C	D				
F0618AL06	7311518181857	1	1	6	18	6	51	AL	5	x	20	
F1225AL06	7311518187651	1	1	12	25	6	70	AL	6	x	50	

					A	B	C	D				
F1225AL08	7311518181864	1	1	12	25	8	70	AL	6	x	50	

## L-AL

# CARBIDE ROTARY BURRS WITH ROUND NOSE CONICAL HEAD FOR ALUMINIUM

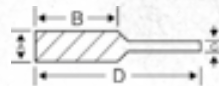

### FEATURES:

- Deburring aluminium and other soft materials
- Use wax to avoid chip build-up
- Special cutting edge suitable for soft materials
- Type of cut: AL = AL-cut
- Stock standard: X = yes

### ASSORTMENT

					A	B	C	D						
L1230AL06	7311518187668	1	1	12	30	6	76	AL	6	x				50

					A	B	C	D						
L1230AL08	7311518181871	1	1	12	30	8	82	AL*	6					50

## A-INT

# CARBIDE ROTARY BURRS WITH CYLINDRICAL HEAD - LONG

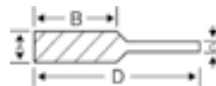

### FEATURES:

- Internal toolpost grinding for centre lathe
- Special cutting edge for high finish
- Type of cut: D = Diamond
- Stock standard: X = yes

### ASSORTMENT

					A	B	C	D						
A0408F03D	7311518197926	1	1	4	8	3	50	D*	20, 20					6
A0610F06D	7311518197933	1	1	6	10	6	65	D*	24, 24					15

					A	B	C	D						
A0810F06D	7311518197957	1	1	8	10	6	65	D	28, 28	x				20

## A/G

# CARBIDE ROTARY BURRS WITH NEEDLE HEAD FOR TYRE REPAIR

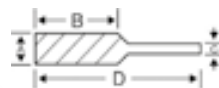

### FEATURES:

- Cleaning and reaming for repairs of tyres
- Maximum speed 1500 r.p.m. Speeds exceeding 1500 r.p.m. generates heat which destroys the bond between the rubber and the steel reinforcement
- Burrs marked with "T" in column "Shank mm" have a triangular shank
- Type of cut: X = X-cut
- Stock standard: X = yes

### ASSORTMENT

					A	B	C	D						
A0320M03X	7311518197773	1	1	3	20	3	40	x	14, 7	x				10
A0625M06X	7311518197780	1	1	6	25	6	65	x	16, 8	x				20
G0645M4.9X	7311518195380	1	1	6	45	T 4.9	75	x*	12, 6					50

					A	B	C	D						
G0845M6.6X	7311518195403	1	1	8	45	T 6.6	90	x*	16, 8					60
G1050M8.3X	7311518195397	1	1	10	50	T 8.3	110	x*	20, 10					70
HSSG-G0645MX	7311518195496	1	1	6	45	6	75	x*	12, 6					50

# HIGH-SPEED STEEL **ROTARY BURRS**



20 PRODUCTS



**BEST CHOICE WHEN THE RISK  
OF IMPACT SHOCK IS HIGH**



USE HSS BURRS WHEN OPTIMAL MACHINING CONDITIONS CAN'T BE MAINTAINED OR WHEN THE RISK OF VIBRATION AND IMPACT SHOCK IS HIGH

PERFECT GEOMETRY BURR HEAD

MADE FROM ONE PIECE:  
REDUCES THE RISK OF BREAKAGE

## HSSG-A

### HSS ROTARY BURRS WITH CYLINDRICAL HEAD

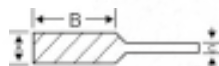

#### FEATURES:

- Rotary burrs, HSS
- High-speed steel burrs are used primarily for machining soft steel, aluminium, bronze, brass, etc.
- High-speed steel burrs are a better choice when optimal machining conditions cannot be maintained or, when the risk of vibration and impact shock are high
- Also usable with low cutting speeds

- Type of cut:
  - M: Medium, for machining unhardened steel and other moderately hard materials under normal conditions
  - EC: Extra coarse, for soft materials when good stock removal is required, counteracts chip build-up between teeth
- Packaging: Plastic box - Individually packed in boxes of 5

#### ASSORTMENT

					A	B	C		
HSSG-A0616M	7311518023379	5	1	6	16	6	M	20	
HSSG-A1020M	7311518023386	5	1	10	20	6	M	30	

					A	B	C		
HSSG-A1225EC	7311518023409	5	1	12	25	6	EC	40	
HSSG-A1225M	7311518023393	5	1	12	25	6	M	40	

## HSSG-C

# HSS ROTARY BURRS WITH CYLINDRICAL ROUND NOSE HEAD

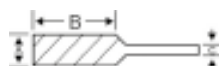

### FEATURES:

- Rotary burrs, HSS
- High-speed steel burrs are used primarily for machining soft steel, aluminium, bronze, brass, etc.
- High-speed steel burrs are a better choice when optimal machining conditions cannot be maintained or, when the risk of vibration and impact shock are high
- Also usable with low cutting speeds

- Type of cut:  
M: Medium, for machining unhardened steel and other moderately hard materials under normal conditions  
EC: Extra coarse, for soft materials when good stock removal is required, counteracts chip build-up between teeth
- Packaging: Plastic box - Individually packed in boxes of 5

### ASSORTMENT

					A	B	C		
HSSG-C0616M	7311518023423	5	1	6	16	6	M	20	
HSSG-C1020M	7311518023430	5	1	10	20	6	M	20	

					A	B	C		
HSSG-C1225EC	7311518023454	5	1	12	25	6	EC	40	
HSSG-C1225M	7311518023447	5	1	12	25	6	M	40	

## HSSG-D

# HSS ROTARY BURRS WITH SPHERICAL HEAD

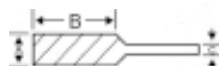

### FEATURES:

- Rotary burrs, HSS
- High-speed steel burrs are used primarily for machining soft steel, aluminium, bronze, brass, etc.
- High-speed steel burrs are a better choice when optimal machining conditions cannot be maintained or, when the risk of vibration and impact shock are high
- Also usable with low cutting speeds

- Type of cut:  
M: Medium, for machining unhardened steel and other moderately hard materials under normal conditions  
EC: Extra coarse, for soft materials when good stock removal is required. Counteracts chip build-up between teeth
- Packaging: Plastic box - Individually packed in boxes of 5

### ASSORTMENT

					A	B	C		
HSSG-D0606M	7311518023461	5	1	6	6	6	M	20	
HSSG-D0807M	7311518023478	5	1	8	7	6	M	20	
HSSG-D1009M	7311518023485	5	1	10	9	6	M	20	

					A	B	C		
HSSG-D1211EC	7311518023508	5	1	12	11	6	EC	20	
HSSG-D1211M	7311518023492	5	1	12	11	6	M	20	

## HSSG-E

# HSS ROTARY BURRS WITH OVAL HEAD

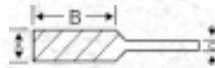

### FEATURES:

- Rotary burrs, HSS
- High-speed steel burrs are used primarily for machining soft steel, aluminium, bronze, brass, etc.
- High-speed steel burrs are a better choice when optimal machining conditions cannot be maintained or, when the risk of vibration and impact shock are high
- Also usable with low cutting speeds
- Type of cut:
  - M: Medium, for machining unhardened steel and other moderately hard materials under normal conditions
  - EC: Extra coarse, for soft materials when good stock removal is required. Counteracts chip build-up between teeth
- Packaging: Plastic box - Individually packed in boxes of 5

### ASSORTMENT

				A	B	C		
HSSG-E0614M	7311518023522	5	1	6	14	6	M	20
HSSG-E1222EC	7311518023546	5	1	12	22	6	EC	30

				A	B	C		
HSSG-E1222M	7311518023539	5	1	12	22	6	M	30

## HSSG-F

# HSS ROTARY BURRS WITH ROUND NOSE TREE HEAD

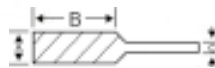

### FEATURES:

- Rotary burrs, HSS
- High-speed steel burrs are used primarily for machining soft steel, aluminium, bronze, brass, etc.
- High-speed steel burrs are a better choice when optimal machining conditions cannot be maintained or, when the risk of vibration and impact shock are high
- Also usable with low cutting speeds
- Type of cut:
  - M: Medium, for machining unhardened steel and other moderately hard materials under normal conditions
- Packaging: Plastic box - Individually packed in boxes of 5

### ASSORTMENT

				A	B	C		
HSSG-F0618M	7311518023560	5	1	6	18	6	M	20

				A	B	C		
HSSG-F1225M	7311518023577	5	1	12	25	6	M	30

## HSSG-G

# HSS ROTARY BURRS WITH POINTED TREE HEAD

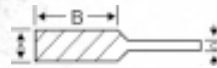

### FEATURES:

- Rotary burrs, HSS
- High-speed steel burrs are used primarily for machining soft steel, aluminium, bronze, brass, etc.
- High-speed steel burrs are a better choice when optimal machining conditions cannot be maintained or, when the risk of vibration and impact shock are high
- Also usable with low cutting speeds

- Type of cut:
  - M: Medium, for machining unhardened steel and other moderately hard materials under normal conditions
  - EC: Extra Coarse, for soft materials when good stock removal is required, counteracts chip build-up between teeth
- Packaging: Plastic box - Individually packed in boxes of 5

### ASSORTMENT

					A	B	C		
HSSG-G0618M	7311518023591	5	1	6	18	6	M	20	
HSSG-G1220M	7311518023607	5	1	12	20	6	M	30	

					A	B	C		
HSSG-G1225EC	7311518023621	5	1	12	25	6	EC	30	
HSSG-G1225M	7311518023614	5	1	12	25	6	M	30	

## HSSG-M

# HSS ROTARY BURRS WITH POINTED NOSE CONICAL HEAD

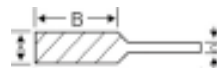

### FEATURES:

- Rotary burrs, HSS
- High-speed steel burrs are used primarily for machining soft steel, aluminium, bronze, brass, etc.
- High-speed steel burrs are a better choice when optimal machining conditions cannot be maintained or, when the risk of vibration and impact shock are high

- Also usable with low cutting speeds
- Type of cut:
  - M: Medium, for machining unhardened steel and other moderately hard materials under normal conditions
- Packaging: Plastic box - Individually packed in boxes of 5

### ASSORTMENT

					A	B	C		
HSSG-M0618M	7311518023638	5	1	6	18	6	M	20	

					A	B	C		
HSSG-M1227M	7311518023645	5	1	12	27	6	M	30	





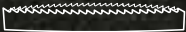
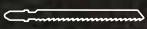
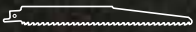

563





# DRILL BITS

## PRODUCT INDEX

<i>DRILL BITS FOR REINFORCED CONCRETE</i>	104
<i>CHISELS FOR REINFORCED CONCRETE</i>	109
<i>DRILL BITS FOR WOOD</i>	112
<i>DRILL BITS FOR METAL</i>	114
<i>STEP DRILL BITS</i>	120

**563**  
PRODUCTS

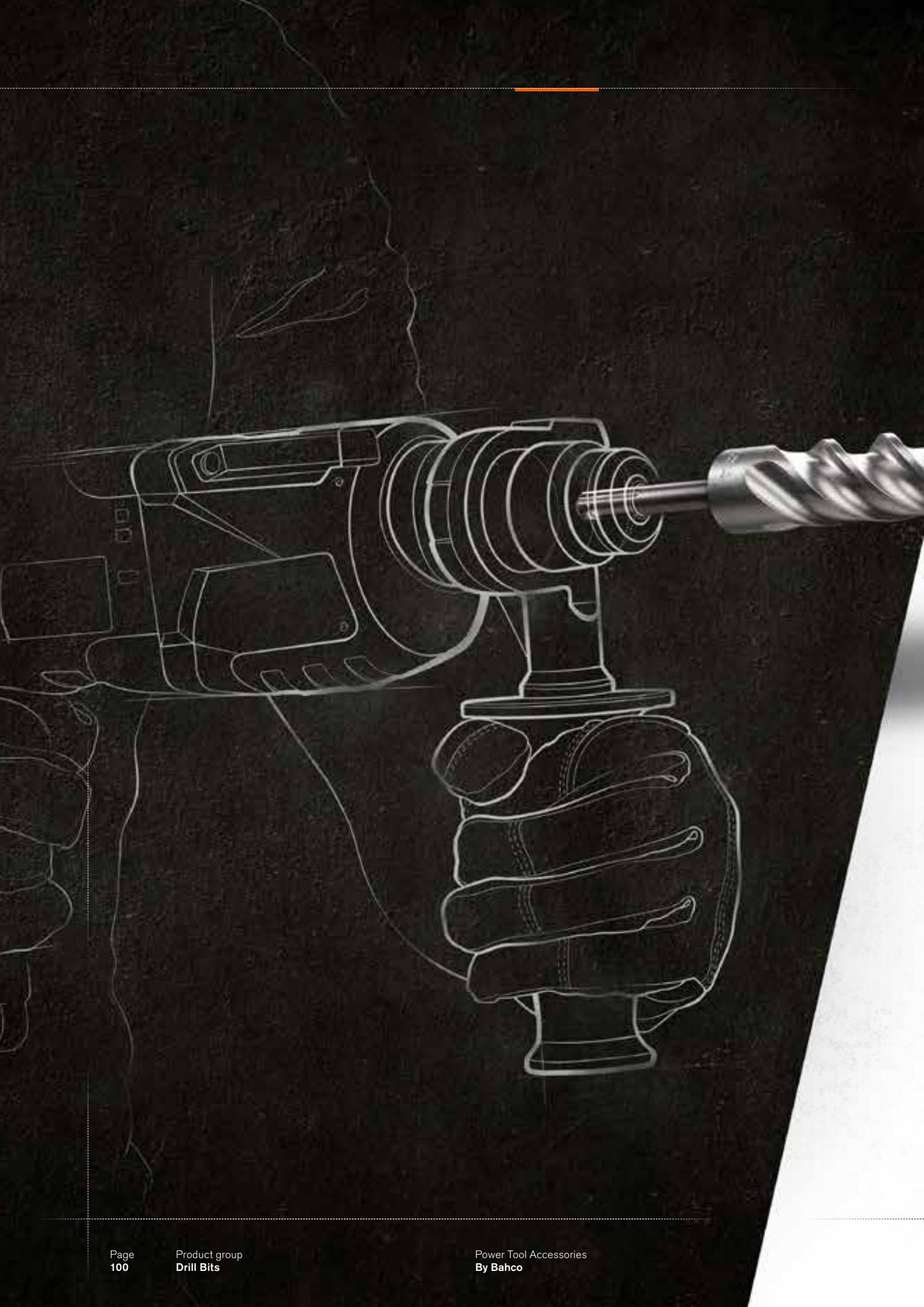

# ***A GROUND-BREAKING SOLUTION FOR EVERY APPLICATION***



***SDS-PLUS AND SDS-MAX DRILL BITS WITH  
CARBIDE SELF-CENTRING SPLIT POINT***



***HEAT-TREATED AND TEMPERED  
WOOD DRILL BITS FOR LONG LIFE***



***HSS-E METAL DRILL BITS  
WITH 5% COBALT FOR HIGH DURABILITY***

563

# FULL OF POWER

**Bahco provides a wide range of professional, high-quality drills bits for use in most applications, and in almost any conditions.**

## SDS DRILL BITS FOR REINFORCED CONCRETE

When you need ultimate power our SDS-Plus and SDS-Max drill bits are up to the job. The carbide head ensures a long lifetime, while the self-centring tip provides you with optimum guidance and control when drilling, even in reinforced concrete.

## DRILL BITS FOR WOOD

We offer a wide selection of drill bits for wood to fit every need. Crafted from heat-treated and tempered high-carbon steel, our range of drill bits for wood feature a positive cutting angle for faster drilling and aggressive chip extraction.

## 5% COBALT HSS-E DRILL BITS FOR METAL

Our professional HSS-E drill bits are manufactured with a 5% cobalt content for increased heat resistance and cutting performance. The top angle of 135° with self-centring split-point tip ensures quick drilling and perfect centring. With the innovative Speed Point, you don't need to pre-punch or use a pilot drill.

# FULL SUPPORT

## SDS DRILL BITS FOR REINFORCED CONCRETE



### SDS-PLUS AND SDS-MAX DRILL BITS

The strong carbide head ensures a long lifetime, even in reinforced concrete.



### MASONRY DRILL BITS

The carbide tip makes this drill suitable for rotary drilling in concrete, lightweight concrete, brick, stone, hollow block, ceramics, marble etc.

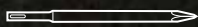

### SDS-PLUS AND SDS-MAX CHISELS

Need even more power? Choose one of the 18 SDS-Plus or SDS-Max chisels for extreme demolition work!

## DRILL BITS FOR WOOD



### AUGER DRILL BITS

Used to drill a high-precision splinter-free hole in all kinds of grained timber. The full screw tip generates a pull, making drilling easier with less manual power.



### FLAT DRILL BITS

These bits are ideal for fast, effective drilling in all grains, in soft and hardwood end-grained timber.



### TWIST DRILL BITS

Recommended for drilling in solid wood, chip-board and wooden fibre boards.

## 5% COBALT HSS-E DRILL BITS FOR METAL



### HSS-E COBALT DRILL BITS

The 135° self-centring split-point tip ensures quick drilling, perfect centring and less drilling pressure. Manufactured with 5% cobalt!



### HSS DRILL BITS

High-Speed Steel drills are suitable for drilling holes in brass, bronze, carbon steel, cast iron, steel alloys and stainless steel.



### STEP DRILLS

Designed for drilling thinner metal sheet, the Bahco step drills with their titanium-nitride surface last four to five times longer than ordinary step drills.



# FULL RANGE

563 PRODUCTS

													
<b>Concrete Drills</b>  3-25 mm   60-600 mm	✓	✓											
<b>SDS-Plus Concrete</b>  4-26 mm   110-1000 mm	✓	✓											
<b>SDS-Plus Reinforced Concrete</b>  5-32 mm   110-1000 mm	✓	✓	✓										
<b>SDS-Max Reinforced Concrete</b>  12-52 mm   340-1320 mm	✓	✓	✓										
<b>SDS-Plus Chisels</b>  20-60 mm   200-250 mm	✓	✓	✓										
<b>SDS-Max Chisels</b>  24-115 mm   240-600 mm	✓	✓	✓										
<b>Twist Drills</b>  3-20 mm   61-250 mm				✓	✓								
<b>Flat Bit Drills</b>  6-40 mm   152-400 mm				✓	✓								
<b>Auger Bit Drills</b>  6-32 mm   230-460 mm				✓	✓								
<b>HSS-R</b>  1-13 mm   34-151 mm							✓	✓	✓				
<b>HSS-G</b>  1-20 mm   34-205 mm							✓	✓	✓			✓	
<b>HSS-E Cobalt</b>  0,5-20 mm   22-205 mm							✓	✓	✓	✓		✓	
<b>Step Drill Bits</b>  4-40,5 mm   76-100 mm								✓					

DRILL BITS FOR REINFORCED CONCRETE

DRILL BITS FOR WOOD

DRILL BITS FOR METAL

# DRILL BITS FOR REINFORCED CONCRETE



217 PRODUCTS



**SDS-MAX DRILLS FOR  
REINFORCED CONCRETE**



LONG LIFETIME,  
HIGH-PERFORMANCE  
HAMMER DRILL BIT

HIGH RESISTANCE TO WEAR  
AND TORSION STRESSES

CANAL FLUTE FOR EFFECTIVE  
DUST REMOVAL

AGGRESSIVE SOLID  
CARBIDE HEAD

SELF-CENTRING  
SPLIT POINT

**UNRIVALLED POWER!**

## SDS-PLUS DRILLS FOR CONCRETE



SELF-CENTRING  
SPLIT POINT

## CONCRETE DRILLS FOR MASONRY



CARBIDE HEAD

4656

## SDS MAX DRILLS FOR REINFORCED CONCRETE

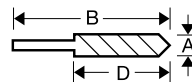

### FEATURES:





- Use/Application: Masonry, Reinforced Concrete, Natural Stone and Artificial Stone
- Specially designed head geometry for better centre drilling, faster drilling progress and precision drilling
- Canal flute provides effective dust removal for increased endurance and reduced heat friction
- To withstand wear the drills are made of high-alloy steel produced with optimised hardening temperatures
- Immediate centring tip, prevents skidding on smooth surfaces
- Specially designed cutting head with 4-cutting edges to enable better precision-drilling in reinforced concrete
- Optimised 4x90° symmetry makes all four carbide cutting edges work evenly and simultaneously
- Fits directly into all hammer drilling machines with SDS max holders





### ASSORTMENT:

				A	B	D
4656-12-340	7314150386932	1	1	12	340	200
4656-12-540	7314150387021	1	1	12	540	400
4656-12-690	7314150387045	1	1	12	690	550
4656-14-340	7314150387069	1	1	14	340	200
4656-14-540	7314150387076	1	1	14	540	400
4656-15-340	7314150387083	1	1	15	340	200
4656-15-540	7314150387090	1	1	15	540	400
4656-16-340	7314150387106	1	1	16	340	200

				A	B	D
4656-16-540	7314150387113	1	1	16	540	400
4656-16-940	7314150387120	1	1	16	940	800
4656-16-1320	7314150387137	1	1	16	1320	1180
4656-18-340	7314150387144	1	1	18	340	200
4656-18-540	7314150387151	1	1	18	540	400
4656-18-940	7314150387168	1	1	18	940	800
4656-18-1320	7314150387175	1	1	18	1320	1180
4656-20-320	7314150387182	1	1	20	320	200



				A	B	D
4656-20-520	7314150387199	1	1	20	520	400
4656-20-920	7314150387205	1	1	20	920	800
4656-20-1320	7314150387212	1	1	20	1320	1180
4656-22-320	7314150387229	1	1	22	320	200
4656-22-520	7314150387236	1	1	22	520	400
4656-22-920	7314150387243	1	1	22	920	800
4656-22-1320	7314150387250	1	1	22	1320	1200
4656-24-320	7314150387267	1	1	24	320	200
4656-24-520	7314150387274	1	1	24	520	400
4656-25-320	7314150387281	1	1	25	320	200
4656-25-520	7314150387298	1	1	25	520	400
4656-25-920	7314150387304	1	1	25	920	800
4656-25-1320	7314150387311	1	1	25	1320	1200
4656-26-520	7314150387328	1	1	26	520	400
4656-28-370	7314150387434	1	1	28	370	250
4656-28-570	7314150387458	1	1	28	570	450
4656-28-670	7314150387489	1	1	28	670	550
4656-28-920	7314150387526	1	1	28	920	800
4656-30-370	7314150387540	1	1	30	370	250
4656-30-570	7314150387571	1	1	30	570	450

				A	B	D
4656-32-370	7314150387595	1	1	32	370	250
4656-32-570	7314150387618	1	1	32	570	450
4656-32-920	7314150387632	1	1	32	920	800
4656-32-1320	7314150387649	1	1	32	1320	1200
4656-35-370	7314150387656	1	1	35	370	250
4656-35-570	7314150387663	1	1	35	570	450
4656-35-670	7314150387670	1	1	35	670	550
4656-37-370	7314150387687	1	1	37	370	250
4656-37-570	7314150387694	1	1	37	570	450
4656-37-920	7314150387700	1	1	37	920	800
4656-38-370	7314150387717	1	1	38	370	250
4656-38-570	7314150387724	1	1	38	570	450
4656-40-370	7314150387731	1	1	40	370	250
4656-40-570	7314150387748	1	1	40	570	450
4656-40-920	7314150387755	1	1	40	920	800
4656-40-1320	7314150387762	1	1	40	1320	1200
4656-45-570	7314150387779	1	1	45	570	450
4656-45-920	7314150387786	1	1	45	920	800
4656-50-570	7314150387793	1	1	50	570	450
4656-52-570	7314150387809	1	1	52	570	450

4651



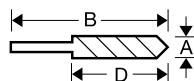

## SDS+ DRILLS FOR REINFORCED CONCRETE











### FEATURES:





- Use/Application: Masonry, Reinforced Concrete, Natural Stone, Artificial Stone
- Specially designed head geometry for better centre drilling, faster drilling progress, precision drilling
- Canal flute provides effective dust removal for increased endurance and reduced heat friction
- To withstand wear the drills are made of high-alloy steel produced with an optimised hardening temperature
- Immediate centring tip prevents skidding on smooth surfaces
- Specially designed cutting head with 4-cutting edges improves precision-drilling in reinforced concrete
- Optimised 4x90° symmetry makes all four carbide cutting edges work evenly and simultaneously
- Fits directly into all hammer drilling machines with SDS-plus and HILTI TE-C drive

### ASSORTMENT:

				A	B	D
4651-5-110	7314150385683	1	1	5	110	50
4651-5-160	7314150385690	1	1	5	160	100
4651-5-210	7314150385706	1	1	5	210	150
4651-5-260	7314150385713	1	1	5	260	200
4651-5,5-110	7314150385720	1	1	5.5	110	50
4651-5,5-160	7314150385737	1	1	5.5	160	100
4651-6-110	7314150385744	1	1	6	110	50
4651-6-160	7314150385751	1	1	6	160	100
4651-6-210	7314150385768	1	1	6	210	150
4651-6-260	7314150385775	1	1	6	260	200
4651-6-310	7314150385782	1	1	6	310	250
4651-6,5-160	7314150385799	1	1	6.5	160	100
4651-6,5-210	7314150385805	1	1	6.5	210	150
4651-6,5-260	7314150385812	1	1	6.5	260	200
4651-6,5-310	7314150385829	1	1	6.5	310	250
4651-7-110	7314150385836	1	1	7	110	50
4651-7-160	7314150386253	1	1	7	160	100

				A	B	D
4651-8-110	7314150386277	1	1	8	110	50
4651-8-160	7314150386284	1	1	8	160	100
4651-8-210	7314150386291	1	1	8	210	150
4651-8-260	7314150386307	1	1	8	260	200
4651-8-310	7314150386314	1	1	8	310	250
4651-8-460	7314150386321	1	1	8	460	400
4651-9-160	7314150386338	1	1	9	160	100
4651-10-110	7314150386345	1	1	10	110	50
4651-10-160	7314150386352	1	1	10	160	100
4651-10-210	7314150386369	1	1	10	210	150
4651-10-260	7314150386376	1	1	10	260	200
4651-10-310	7314150386383	1	1	10	310	250
4651-10-450	7314150386390	1	1	10	450	390
4651-10-600	7314150386406	1	1	10	600	540
4651-10-1000	7314150386413	1	1	10	1000	940
4651-12-160	7314150386529	1	1	12	160	110
4651-12-210	7314150386536	1	1	12	210	160

				A	B	D
4651-12-260	7314150386543	1	1	12	260	210
4651-12-310	7314150386550	1	1	12	310	260
4651-12-450	7314150386567	1	1	12	450	400
4651-12-600	7314150386574	1	1	12	600	550
4651-12-1000	7314150386581	1	1	12	1000	950
4651-14-160	7314150386598	1	1	14	160	110
4651-14-210	7314150386604	1	1	14	210	160
4651-14-260	7314150386611	1	1	14	260	210
4651-14-310	7314150386628	1	1	14	310	260
4651-14-450	7314150386635	1	1	14	450	400
4651-14-600	7314150386642	1	1	14	600	550
4651-14-1000	7314150386659	1	1	14	1000	950
4651-15-160	7314150386666	1	1	15	160	110
4651-15-260	7314150386673	1	1	15	260	210
4651-15-450	7314150386680	1	1	15	450	400
4651-16-160	7314150386697	1	1	16	160	110
4651-16-210	7314150386710	1	1	16	210	160
4651-16-260	7314150386727	1	1	16	260	210
4651-16-310	7314150386734	1	1	16	310	260

				A	B	D
4651-16-450	7314150386741	1	1	16	450	400
4651-16-600	7314150386758	1	1	16	600	550
4651-16-1000	7314150386765	1	1	16	1000	950
4651-18-250	7314150386789	1	1	18	250	200
4651-18-450	7314150386796	1	1	18	450	400
4651-20-250	7314150386802	1	1	20	250	200
4651-20-450	7314150386819	1	1	20	450	400
4651-22-250	7314150386826	1	1	22	250	200
4651-22-450	7314150386833	1	1	22	450	400
4651-24-250	7314150386840	1	1	24	250	200
4651-24-450	7314150386857	1	1	24	450	400
4651-25-250	7314150386864	1	1	25	250	200
4651-25-450	7314150386871	1	1	25	450	400
4651-28-250	7314150386888	1	1	28	250	200
4651-28-450	7314150386895	1	1	28	450	400
4651-30-250	7314150386901	1	1	30	250	200
4651-30-450	7314150386918	1	1	30	450	400
4651-32-450	7314150386925	1	1	32	450	400

## 4652 SDS+ DRILLS FOR CONCRETE

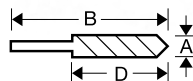









### FEATURES:

- Use/Application: Masonry, Concrete, Natural Stone, Artificial Stone
- Particularly suitable for drilling plug holes for fastenings
- Canal flute provides effective dust removal for increased endurance and reduced heat friction
- To withstand wear, the drills are made of high-alloy steel produced with optimised hardening temperatures

- Immediate centring tip prevents skidding on smooth surfaces
- Enlarged rebar chamfers (+35°) prevent side tip damages
- Fits directly into all hammer drilling machines with SDS-plus and HILTI TE-C drive

### ASSORTMENT:

				A	B	D
4652-4-110	7314150384365	1	1	4	110	50
4652-4-160	7314150384372	1	1	4	160	100
4652-5-110	7314150384815	1	1	5	110	50
4652-5-160	7314150384839	1	1	5	160	100
4652-5-210	7314150384846	1	1	5	210	150
4652-5,5-110	7314150384853	1	1	5.5	110	50
4652-5,5-160	7314150384860	1	1	5.5	160	100
4652-6-110	7314150384877	1	1	6	110	50
4652-6-160	7314150384891	1	1	6	160	100
4652-6-210	7314150384907	1	1	6	210	150
4652-6-260	7314150384969	1	1	6	260	200
4652-6,5-110	7314150384976	1	1	6.5	110	50
4652-6,5-160	7314150384990	1	1	6.5	160	100
4652-7-110	7314150385003	1	1	7	110	50
4652-7-160	7314150391981	1	1	7	160	100
4652-8-110	7314150385034	1	1	8	110	50
4652-8-160	7314150385058	1	1	8	160	100
4652-8-210	7314150385065	1	1	8	210	150
4652-8-260	7314150385072	1	1	8	260	200

				A	B	D
4652-8-460	7314150385089	1	1	8	460	400
4652-9-160	7314150385096	1	1	9	160	100
4652-9-210	7314150385102	1	1	9	210	150
4652-10-110	7314150385119	1	1	10	110	50
4652-10-160	7314150385126	1	1	10	160	100
4652-10-210	7314150385133	1	1	10	210	150
4652-10-260	7314150385140	1	1	10	260	200
4652-10-310	7314150385164	1	1	10	310	250
4652-10-450	7314150385171	1	1	10	450	400
4652-10-600	7314150385188	1	1	10	600	550
4652-11-160	7314150385195	1	1	11	160	100
4652-11-210	7314150385201	1	1	11	210	150
4652-11-260	7314150385218	1	1	11	260	200
4652-12-160	7314150385225	1	1	12	160	100
4652-12-210	7314150385232	1	1	12	210	150
4652-12-260	7314150385249	1	1	12	260	200
4652-12-310	7314150385256	1	1	12	310	250
4652-12-450	7314150385263	1	1	12	450	400
4652-12-600	7314150385270	1	1	12	600	550

				A	B	D
4652-12-1000	7314150385287	1	1	12	1000	950
4652-13-160	7314150385294	1	1	13	160	100
4652-13-310	7314150385300	1	1	13	310	250
4652-14-160	7314150385317	1	1	14	160	100
4652-14-210	7314150385324	1	1	14	210	150
4652-14-260	7314150385331	1	1	14	260	200
4652-14-310	7314150385348	1	1	14	310	250
4652-14-450	7314150385355	1	1	14	450	400
4652-14-600	7314150385362	1	1	14	600	550
4652-14-1000	7314150385379	1	1	14	1000	950
4652-15-160	7314150385386	1	1	15	160	100
4652-15-260	7314150385393	1	1	15	260	200
4652-16-160	7314150385409	1	1	16	160	100
4652-16-210	7314150385416	1	1	16	210	150
4652-16-260	7314150385423	1	1	16	260	200
4652-16-310	7314150385430	1	1	16	310	250
4652-16-450	7314150385447	1	1	16	450	400
4652-16-600	7314150385454	1	1	16	600	550
4652-16-800	7314150385461	1	1	16	800	750
4652-16-1000	7314150385478	1	1	16	1000	950

				A	B	D
4652-18-200	7314150385485	1	1	18	200	150
4652-18-300	7314150385492	1	1	18	300	250
4652-18-450	7314150385508	1	1	18	450	400
4652-18-1000	7314150385515	1	1	18	1000	950
4652-20-200	7314150385522	1	1	20	200	150
4652-20-300	7314150385539	1	1	20	300	250
4652-20-450	7314150385546	1	1	20	450	400
4652-20-600	7314150385553	1	1	20	600	550
4652-20-1000	7314150385560	1	1	20	1000	950
4652-22-250	7314150385577	1	1	22	250	200
4652-22-450	7314150385584	1	1	22	450	400
4652-22-600	7314150385591	1	1	22	600	550
4652-22-1000	7314150385607	1	1	22	1000	950
4652-24-250	7314150385614	1	1	24	250	200
4652-24-450	7314150385621	1	1	24	450	400
4652-25-250	7314150385638	1	1	25	250	200
4652-25-450	7314150385645	1	1	25	450	400
4652-25-1000	7314150385652	1	1	25	1000	950
4652-26-250	7314150385669	1	1	26	250	200
4652-26-450	7314150385676	1	1	26	450	400

4641

## DRILLS FOR MASONRY

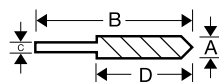

### FEATURES:

- Masonry drill for percussion drilling in concrete, brick, stone, ceramic tiles and marble etc
- Shank of low-alloy, hardened and tempered tool steel
- Black-oxidised surface with ground diameter
- Carbide tip ensures high drilling capacity and long-life
- High resistance to wear and torsion stresses

### ASSORTMENT

				A	B	C	D
4641-3-60	7314150382859	1	1	3	60	3	35
4641-4-75	7314150382866	1	1	4	75	4	45
4641-5-85	7314150382873	1	1	5	85	5	40
4641-5-150	7314150382880	1	1	5	150	5	80
4641-5,5-85	7314150382897	1	1	5,5	85	5,5	40
4641-6-100	7314150383016	1	1	6	100	6	55
4641-6-150	7314150383023	1	1	6	150	6	85
4641-6,5-100	7314150383030	1	1	6,5	100	6,5	55
4641-7-100	7314150383047	1	1	7	100	7	55
4641-8-120	7314150383054	1	1	8	120	8	70
4641-8-200	7314150383061	1	1	8	200	8	130
4641-9-120	7314150383078	1	1	9	120	9	70
4641-10-120	7314150383085	1	1	10	120	10	70
4641-10-200	7314150383115	1	1	10	200	10	130
4641-11-150	7314150383122	1	1	11	150	10	90
4641-12-150	7314150383139	1	1	12	150	10	90
4641-12-200	7314150383146	1	1	12	200	10	130
4641-13-150	7314150383153	1	1	13	150	10	90
4641-14-150	7314150383160	1	1	14	150	11	90

				A	B	C	D
4641-16-150	7314150383177	1	1	16	150	11	90
4641-6-400	7314150383184	1	1	6	400	6	300
4641-8-400	7314150383191	1	1	8	400	8	300
4641-10-400	7314150383207	1	1	10	400	10	300
4641-10-600	7314150383221	1	1	10	600	10	450
4641-12-400	7314150383238	1	1	12	400	10	300
4641-12-600	7314150383245	1	1	12	600	10	450
4641-14-400	7314150383252	1	1	14	400	11	300
4641-14-600	7314150383269	1	1	14	600	11	450
4641-16-400	7314150383276	1	1	16	400	11	300
4641-16-600	7314150383283	1	1	16	600	11	450
4641-18-400	7314150383290	1	1	18	400	11	300
4641-18-600	7314150383306	1	1	18	600	11	450
4641-20-400	7314150383313	1	1	20	400	11	300
4641-20-600	7314150383320	1	1	20	600	11	450
4641-22-400	7314150383337	1	1	22	400	11	300
4641-24-400	7314150383344	1	1	24	400	11	300
4641-25-400	7314150383351	1	1	25	400	11	300

4641-PB

## DRILL SET FOR MASONRY



### FEATURES:

- Masonry drill for percussion drilling in concrete, brick, stone, ceramic tiles and marble etc
- Shank of low-alloy, hardened and tempered tool steel
- Black-oxidised surface with ground diameter
- Carbide tip ensures high drilling capacity and long-life
- High resistance to wear and torsion stresses

### ASSORTMENT:

				
4641-PB	7314150383368	1	5	130

# CHISELS FOR REINFORCED CONCRETE



26 PRODUCTS

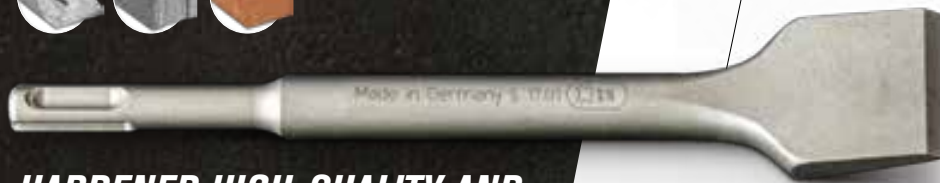

**HARDENED HIGH-QUALITY AND WEAR-RESISTANT TOOL STEEL**

CHISELS ARE AVAILABLE IN 10 DIFFERENT SHAPES FOR THE MOST DEMANDING APPLICATIONS

FITS DIRECTLY INTO THE MOST COMMON HAMMER MACHINES

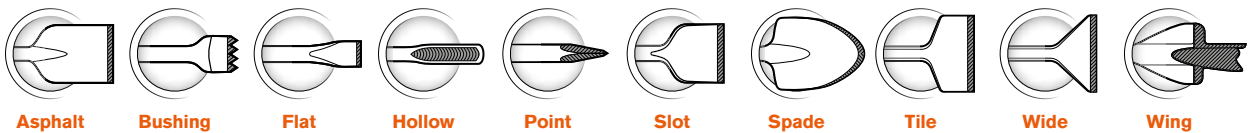

## 4659 SDS MAX CHISELS FOR REINFORCED CONCRETE

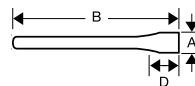

### FEATURES:

- Use Application: Masonry, Reinforced Concrete, Natural Stone, Artificial Stone for light renovation and restoration chisel work
- Hardened high-quality and wear-resistant tool steel
- Point chisels are suitable for breakthroughs, wire slots and demolition work
- The flat chisel has a higher breaking power than point chisels, making well-directed use possible and allowing most demolition work and breakthroughs

- Scraping and spade chisels have a wider working tip which allows more materials to be removed, spades can also be used for removal of hard clay
- Hollow chisel, wing and wing canal are different versions created for the precise production of channels in masonry and concrete
- Tile chisel is ideal for removing tiles (floor and wall)
- Fits directly into all hammer drilling machines with SDS max holders

### ASSORTMENT:

				A	B	D
4659-ASPHALT-40	7314150388080	1	1	90	400	ASPHALT
4659-BUSHING-24	7314150388097	1	1	45	240	BUSHING
4659-FLAT-28	7314150387922	1	1	24	280	FLAT
4659-FLAT-40	7314150387939	1	1	24	400	FLAT
4659-FLAT-60	7314150387946	1	1	24	600	FLAT
4659-HOLLOW-30	7314150387991	1	1	26	300	HOLLOW
4659-POINT-28	7314150387892	1	1		280	POINT
4659-POINT-28-4	7314150388066	1	1	38	280	POINT
4659-POINT-40	7314150387908	1	1		400	POINT

				A	B	D
4659-POINT-60	7314150387915	1	1		600	POINT
4659-SLOT-30-3	7314150388028	1	1	22	300	SLOT
4659-SPADE-40	7314150388073	1	1	110	400	SPADE
4659-TILE-30-5	7314150388042	1	1	50	300	TILE
4659-TILE-30-8	7314150388059	1	1	80	300	TILE
4659-WIDE-30-8	7314150387953	1	1	80	300	WIDE
4659-WIDE-35-11	7314150387977	1	1	115	350	WIDE
4659-WIDE-36-5	7314150387984	1	1	50	360	WIDE
4659-WING-C38-3	7314150388011	1	1	35	380	WING

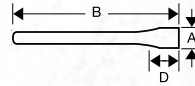
**FEATURES:**

- Use Application: Masonry, Reinforced Concrete, Natural Stone, Artificial Stone for light chisel work in renovation and restoration
- Hardened high-quality and wear-resistant tool steel
- Point chisels are suitable for breakthroughs and wire slots as well as demolition work
- The flat chisel has a higher breaking power than point chisels, making well-directed use possible and the tool suitable for most demolition work
- Scraping and spade chisels have a wider working tip which helps to remove more materials, spades can also be used for removal of hard clay
- Hollow, wing and wing canal are all different versions of chisels that can be used for the precise production of channels in masonry and concrete
- Tile chisel is ideal for removing tiles (floor and wall)
- Fits directly into all hammer drilling machines with SDS-plus and HILTI TE-C drive

**ASSORTMENT:**

				A	B	D
4655-FLAT-250	7314150387823	1	1	20	250	FLAT
4655-HOLLOW-240	7314150387847	1	1	22	240	HOLLOW
4655-POINT-250	7314150387816	1	1		250	POINT
4655-SLOT-25032	7314150387885	1	1	32	250	SLOT

				A	B	D
4655-TILE-20040	7314150387861	1	1	38	200	TILE
4655-TILE-25060	7314150387878	1	1	60	250	TILE
4655-WIDE-20040	7314150387830	1	1	38	200	WIDE
4655-WING-C-250	7314150387854	1	1	22	250	WING

**APPLICATION:**  
Concrete

**PRODUCT:**  
SDS-plus Concrete Drill Bit



# DRILL BITS FOR WOOD

86 PRODUCTS



**AUGER DRILLS FOR WOOD**



HEAT-TREATED ALL OVER FOR EXTREME DURABILITY

ONE SECTION OF THE SHANK HAS A HEXAGONAL SHANK FOR A FIRM GRIP IN THE CHUCK

SPIRALS WITH LEVIN PATTERN

MADE OF CHROME VANADIUM AND LACQUERED FOR RUST PROTECTION

FULL SCREW TIP

**FULL LENGTH HEAT-TREATED FOR EXTREME DURABILITY**

## FLAT DRILLS FOR WOOD



POSITIVE CUTTING ANGLE FOR FASTER DRILLING

## TWIST DRILLS FOR WOOD



LIP AND SPUR DRILL

9626

## AUGER DRILLS FOR WOOD

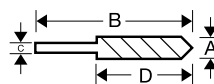

### FEATURES:

- Auger bit for drilling in wood
- One section of tang with hexagonal shank for firm grip in the chuck. Additional 15mm long section with four flat sides, suitable for hand braces





- Spirals with Levin pattern
- Lacquered for rust protection
- 460 mm long auger bit for drilling in wood





### ASSORTMENT:

				A	B	C	D
9626-6	7314150388806	1	1	6	230	5.5	155
9626-7	7314150388813	1	1	7	230	6.5	155
9626-8	7314150388820	1	1	8	230	7.5	155
9626-9	7314150388837	1	1	9	230	8.5	155
9626-10	7314150388844	1	1	10	230	9.5	155
9626-11	7314150388851	1	1	11	230	10.5	155
9626-12	7314150388868	1	1	12	230	11.5	155
9626-13	7314150388875	1	1	13	230	12.5	155
9626-14	7314150388882	1	1	14	230	12.5	155
9626-16	7314150388899	1	1	16	230	12.5	155
9626-18	7314150388905	1	1	18	230	12.5	155
9626-20	7314150388912	1	1	20	230	12.5	155
9626-22	7314150388929	1	1	22	230	12.5	155
9626-23	7314150388936	1	1	23	230	12.5	155

				A	B	C	D
9626-24	7314150388943	1	1	24	230	12.5	155
9626-25	7314150388950	1	1	25	230	12.5	155
9626-26	7314153024237	1	1	26	230	12.5	155
9626-28	7314150388967	1	1	28	230	12.5	155
9626-30	7314150388974	1	1	30	230	12.5	155
9626-32	7314150388981	1	1	32	230	12.5	155
9627-6-460	7314150388998	1	1	6	460	5.5	385
9627-8-460	7314150389001	1	1	8	460	7.5	385
9627-10-460	7314150389018	1	1	10	460	9.5	385
9627-12-460	7314150389025	1	1	12	460	11.5	385
9627-14-460	7314150389032	1	1	14	460	12.5	385
9627-16-460	7314150389049	1	1	16	460	12.5	385
9627-18-460	7314150389056	1	1	18	460	12.5	385
9627-20-460	7314150389063	1	1	20	460	12.5	385



				A	B	C	D
9627-22-460	7314150389070	1	1	22	460	12.5	385
9627-24-460	7314150389087	1	1	24	460	12.5	385
9627-26-460	7314150389094	1	1	26	460	12.5	385

				A	B	C	D
9627-28-460	7314150389100	1	1	28	460	12.5	385
9627-30-460	7314150389117	1	1	30	460	12.5	385
9627-32-460	7314150389124	1	1	32	460	12.5	385

9629

## FLAT DRILLS FOR WOOD

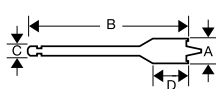









### FEATURES:

- The flat bit has a positive cutting angle for faster drilling than conventional bits

- High-carbon steel, heat treated all over. Hardened blade forged directly from the round shaft
- 400 mm long flat bit drill for drilling wood

### ASSORTMENT:

				A	B	C	D
9629-6	7314150388417	1	1	6	152	6.35	38
9629-8	7314150388462	1	1	8	152	6.35	38
9629-10	7314150388479	1	1	10	152	6.35	38
9629-12	7314150388486	1	1	12	152	6.35	42
9629-14	7314150388493	1	1	14	152	6.35	42
9629-16	7314150388509	1	1	16	152	6.35	42
9629-18	7314150388516	1	1	18	152	6.35	42
9629-20	7314150388523	1	1	20	152	6.35	42
9629-22	7314150388530	1	1	22	152	6.35	42
9629-24	7314150388547	1	1	24	152	6.35	46
9629-25	7314150388554	1	1	25	152	6.35	46
9629-26	7314150388561	1	1	26	152	6.35	46
9629-28	7314150388578	1	1	28	152	6.35	46
9629-30	7314150388585	1	1	30	152	6.35	46
9629-32	7314150388592	1	1	32	152	6.35	46
9629-36	7314150388608	1	1	36	152	6.35	46

				A	B	C	D
9629-38	7314150388615	1	1	38	160	6.35	46
9629-40	7314150388622	1	1	40	160	6.35	46
9631-6-400	7314150388646	1	1	6	400	6.35	38
9631-8-400	7314150388677	1	1	8	400	6.35	38
9631-10-400	7314150388684	1	1	10	400	6.35	38
9631-12-400	7314150388691	1	1	12	400	6.35	42
9631-14-400	7314150388707	1	1	14	400	6.35	42
9631-16-400	7314150388714	1	1	16	400	6.35	42
9631-18-400	7314150388721	1	1	18	400	6.35	42
9631-20-400	7314150388738	1	1	20	400	6.35	42
9631-22-400	7314150388745	1	1	22	400	6.35	42
9631-26-400	7314150388769	1	1	26	400	6.35	46
9631-28-400	7314150388776	1	1	28	400	6.35	46
9631-30-400	7314150388783	1	1	30	400	6.35	46
9631-32-400	7314150388790	1	1	32	400	6.35	46
9631-24-400	7314150388752	1	1	24	400	6.35	46

9646

## TWIST DRILLS FOR WOOD

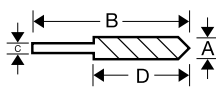









### FEATURES:

- Made of hardened and tempered, chrome-vanadium steel
- Precision ground

- 250 mm long Lip and Spur drill for drilling solid wood, chipboard and wood fibre board

### ASSORTMENT:

				A	B	C	D
9646-3	7314150388189	1	1	3	61	3	33
9646-4	7314150388202	1	1	4	75	4	43
9646-5	7314150388219	1	1	5	86	5	52
9646-6	7314150388226	1	1	6	97	6	60
9646-7	7314150388233	1	1	7	109	7	69
9646-8	7314150388240	1	1	8	117	8	75
9646-9	7314150388257	1	1	9	125	9	80
9646-10	7314150388264	1	1	10	133	10	87
9646-11	7314150388288	1	1	11	142	9.95	89
9646-12	7314150388295	1	1	12	151	9.95	96

				A	B	C	D
9646-13	7314150388301	1	1	13	151	9.95	96
9646-14	7314150388318	1	1	14	151	9.95	97
9646-15	7314150388325	1	1	15	160	9.95	100
9646-16	7314150388332	1	1	16	160	9.95	100
9646-18	7314150388349	1	1	18	180	9.95	120
9646-20	7314150388356	1	1	20	200	9.95	130
9646-6-250	7314150388363	1	1	6	250	6	200
9646-8-250	7314150388370	1	1	8	250	8	200
9646-10-250	7314150388387	1	1	10	250	10	200
9646-12-250	7314150388400	1	1	12	250	9.95	200

# DRILL BITS FOR METAL

34 PRODUCTS



## COBALT HSS-E DRILLS FOR METAL



5% COBALT FOR EXTRA DURABILITY

HEAT-TREATED ALL OVER FOR EXTREME DURABILITY

GROUND FLUTES ENABLES FAST DRILLING AND HIGH PRECISION

NO PRE-PUNCH THANKS TO THE INNOVATIVE SPEED POINT

CRAFTED WITH 5% COBALT FOR INCREASED HEAT RESISTANCE AND CUTTING PERFORMANCE



TOP ANGLE OF 135° WITH SELF-CENTRING SPLIT-POINT TIP

## HSS-G DRILLS FOR METAL



GROUND FLUTES ENABLE FAST DRILLING AND HIGH PRECISION

## HSS-R DRILLS FOR METAL



ROLLED FLUTE WITH HIGH ELASTICITY

4411

## COBALT HSS-E DRILLS FOR METAL

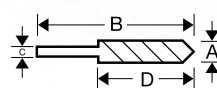





### FEATURES:





- The Cobalt High-speed steel (HSS) provides long-lasting high performance when drilling stainless steel materials
- Cobalt drills work brilliantly on alloyed and non-alloyed steel, stainless steel, cast iron, cast steel and acid and heat-resistant steels
- Ground flutes enable fast drilling and high precision
- Top angle of 135° with self-centring split-point tip for quick cutting and perfect centring
- Speed Point, no need to pre-punch or pilot drill up to 10mm diameter
- Drill bits have a cylindrical shank (shank equal to drill bit diameter) and are designed for use in drill stands and drivers
- Manufactured to DIN 338 N
- Size range 1mm to 13mm
- Size 1mm up to 4mm, two drills in each tube

### ASSORTMENT:

				A	B	C	D
4411-1.00	7314150372744	2	1	1	34	1	12
4411-1.50	7314150372768	2	1	1.5	40	1.5	18
4411-2.00	7314150372775	2	1	2	49	2	24
4411-2.50	7314150372782	2	1	2.5	57	2.5	30
4411-3.00	7314150372799	2	1	3	61	3	33
4411-3.25	7314150372805	2	1	3.25	65	3.25	36
4411-3.30	7314150372812	2	1	3.3	65	3.3	36
4411-3.50	7314150372829	2	1	3.5	70	3.5	39





				A	B	C	D
4411-4.00	7314150372836	2	1	4	75	4	43
4411-4.20	7314150372843	1	1	4.2	75	4.2	43
4411-4.25	7314150372850	1	1	4.25	75	4.25	43
4411-4.50	7314150372867	1	1	4.5	80	4.5	47
4411-5.00	7314150372874	1	1	5	86	5	52
4411-5.50	7314150372881	1	1	5.5	93	5.5	57
4411-6.00	7314150372898	1	1	6	93	6	57
4411-6.50	7314150372904	1	1	6.5	101	6.5	63





				A	B	C	D
4411-6.80	7314150372911	1	1	6.8	109	6.8	69
4411-7.00	7314150372928	1	1	7	109	7	69
4411-7.50	7314150372935	1	1	7.5	109	7.5	69
4411-8.00	7314150372942	1	1	8	117	8	75
4411-8.50	7314150372959	1	1	8.5	117	8.5	75
4411-9.00	7314150372966	1	1	9	125	9	81

				A	B	C	D
4411-9.50	7314150394463	1	1	9.5	125	9.5	87
4411-10.00	7314150372973	1	1	10	125	10	87
4411-10.20	7314150372980	1	1	10.2	133	10.2	87
4411-11.00	7314150372997	1	1	11	142	11	94
4411-12.00	7314150373000	1	1	12	151	12	101
4411-13.00	7314150373017	1	1	13	151	13	101

### INDUSTRIAL PACK:

- Size range 0.5 to 20mm
- In boxes of 10, 5 or 1, depending on dimensions

				A	B	C	D
4511-0.50-10P	7314150373079	10	1	0.5	22	0.5	6
4511-0.75-10P	7314150373062	10	1	0.75	28	0.75	9
4511-1.00-10P	7314150373055	10	1	1	34	1	12
4511-1.50-10P	7314150373086	10	1	1.5	40	1.5	18
4511-1.75-10P	7314150373093	10	1	1.75	46	1.75	22
4511-2.00-10P	7314150373109	10	1	2	49	2	24
4511-2.50-10P	7314150373116	10	1	2.5	57	2.5	30
4511-2.70-10P	7314150373123	10	1	2.7	61	2.7	33
4511-2.90-10P	7314150373130	10	1	2.9	61	2.9	33
4511-3.00-10P	7314150373147	10	1	3	61	3	33
4511-3.10-10P	7314150373185	10	1	3.1	65	3.1	36
4511-3.25-10P	7314150373192	10	1	3.25	65	3.25	36
4511-3.30-10P	7314150373208	10	1	3.3	65	3.3	36
4511-3.50-10P	7314150373215	10	1	3.5	70	3.5	39
4511-3.80-10P	7314150373222	10	1	3.8	75	3.8	43
4511-4.00-10P	7314150373239	10	1	4	75	4	43
4511-4.20-10P	7314150373246	10	1	4.2	75	4.2	43
4511-4.50-10P	7314150373253	10	1	4.5	80	4.5	47
4511-4.80-10P	7314150373260	10	1	4.8	86	4.8	52
4511-5.00-10P	7314150373277	10	1	5	86	5	52
4511-5.20-10P	7314150373284	10	1	5.2	86	5.2	52
4511-5.50-10P	7314150373291	10	1	5.5	93	5.5	57
4511-6.00-10P	7314150373307	10	1	6	93	6	57
4511-6.20-10P	7314150373314	10	1	6.2	101	6.2	63
4511-6.50-10P	7314150373321	10	1	6.5	101	6.5	63
4511-6.80-10P	7314150373338	10	1	6.8	109	6.8	69
4511-7.00-10P	7314150373345	10	1	7	109	7	69
4511-7.20-10P	7314150373352	10	1	7.2	109	7.2	69
4511-7.50-10P	7314150373369	10	1	7.5	109	7.5	69
4511-7.80-10P	7314150373376	10	1	7.8	117	7.8	75
4511-8.00-10P	7314150373383	10	1	8	117	8	75
4511-8.50-10P	7314150373390	10	1	8.5	117	8.5	75

				A	B	C	D
4511-8.60-10P	7314150373406	10	1	8.6	125	8.6	81
4511-8.80-10P	7314150373413	10	1	8.8	125	8.8	81
4511-9.00-10P	7314150373420	10	1	9	125	9	81
4511-9.20-10P	7314150373437	10	1	9.2	125	9.2	81
4511-9.50-10P	7311518339081	10	1	9.5	125	9.5	81
4511-9.60-10P	7314150373451	10	1	9.6	133	9.6	87
4511-10.00-5P	7314150392247	5	1	10	133	10	87
4511-10.20-5P	7314150392254	5	1	10.2	133	10.2	87
4511-10.30-5P	7314150392261	5	1	10.30	133	10.30	87
4511-10.50-5P	7314150392278	5	1	10.5	133	10.5	87
4511-10.80-5P	7314150392285	5	1	10.8	142	10.8	94
4511-11.00-5P	7314150392292	5	1	11	142	11	94
4511-11.50-5P	7314150392308	5	1	11.5	142	11.5	94
4511-12.00-5P	7314150392315	5	1	12	151	12	101
4511-12.50-5P	7314150392322	5	1	12.5	151	12.5	101
4511-12.80-5P	7314150392339	5	1	12.8	151	12.8	101
4511-13.00-5P	7314150392346	5	1	13	151	13	101
4511-13.50-1P	7314150392353	1	1	13.5	160	13.5	108
4511-14.00-1P	7314150392360	1	1	14	160	14	108
4511-14.50-1P	7314150392377	1	1	14.5	169	14.5	114
4511-15.00-1P	7314150392384	1	1	15	169	15	114
4511-15.50-1P	7314150392391	1	1	15.5	169	15.5	120
4511-16.00-1P	7314150392407	1	1	16	178	16	120
4511-16.50-1P	7314150392414	1	1	16.5	184	16.5	125
4511-17.00-1P	7314150392421	1	1	17	184	17	125
4511-17.50-1P	7314150392438	1	1	17.5	191	17.5	130
4511-18.00-1P	7314150392445	1	1	18	191	18	130
4511-18.50-1P	7314150392452	1	1	18.5	198	18.5	135
4511-19.00-1P	7314150392469	1	1	19	198	19	135
4511-19.50-1P	7314150392476	1	1	19.5	205	19.5	140
4511-20.00-1P	7314150392483	1	1	20	205	20	140

4413

## HSS-G DRILLS FOR METAL

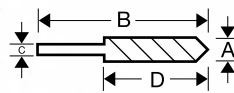

### FEATURES:

- High-speed steel (HSS) drill for drilling in bronze, brass, carbon steel, cast iron, alloy steel and stainless steel
- Ground flutes enable fast drilling and high precision
- Top angle of 130° with self-centring split-point tip for quick cutting and perfect centring
- Speed Point, no need to pre-punch or pilot drill up to 10mm diameter

- Drill bits have a cylindrical shank (shank equal to drill bit diameter) and are designed for use in drill stands and drivers
- Manufactured to DIN 338 N
- Size range 1mm to 13mm
- Size 1mm up to 4mm, two drills in each tube

### ASSORTMENT:

				A	B	C	D
4413-1.00	7314150371754	2	1	1	34	1	12
4413-1.50	7314150371761	2	1	1.5	40	1.5	18
4413-2.00	7314150371785	2	1	2	49	2	24
4413-2.50	7314150371792	2	1	2.5	57	2.5	30
4413-3.00	7314150371815	2	1	3	61	3	33
4413-3.25	7314150371822	2	1	3.25	65	3.25	36
4413-3.30	7314150371877	2	1	3.3	65	3.3	36
4413-3.50	7314150371884	2	1	3.5	70	3.5	39
4413-4.00	7314150371891	2	1	4	75	4	43
4413-4.20	7314150371907	1	1	4.2	75	4.2	43
4413-4.25	7314150371914	1	1	4.25	75	4.25	43
4413-4.50	7314150371921	1	1	4.5	80	4.5	47
4413-5.00	7314150371938	1	1	5	86	5	52
4413-5.50	7314150371945	1	1	5.5	93	5.5	57





				A	B	C	D
4413-6.00	7314150371952	1	1	6	93	6	57
4413-6.50	7314150371969	1	1	6.5	101	6.5	63
4413-6.80	7314150371976	1	1	6.8	109	6.8	69
4413-7.00	7314150371983	1	1	7	109	7	69
4413-7.50	7314150371990	1	1	7.5	109	7.5	69
4413-8.00	7314150372003	1	1	8	117	8	75
4413-8.50	7314150372010	1	1	8.5	117	8.5	75
4413-9.00	7314150372027	1	1	9	125	9	81
4413-9.50	7314150394456	1	1	9.5	125	9.5	87
4413-10.00	7314150372034	1	1	10	133	10	87
4413-10.20	7314150372041	1	1	10.2	133	10.2	87
4413-11.00	7314150372058	1	1	11	142	11	94
4413-12.00	7314150372065	1	1	12	151	12	101
4413-13.00	7314150372072	1	1	13	151	13	101





### INDUSTRIAL PACK:

- Size range 1 to 20mm
- In boxes of 10, 5 or 1, depending on dimensions

				A	B	C	D
4513-1.00-10P	7314150372119	10	1	1	34	1	12
4513-1.50-10P	7314150372126	10	1	1.5	40	1.5	18
4513-1.75-10P	7314150372133	10	1	1.75	46	1.75	22
4513-2.00-10P	7314150372140	10	1	2	49	2	24
4513-2.50-10P	7314150372157	10	1	2.5	57	2.5	30
4513-2.70-10P	7314150372164	10	1	2.7	61	2.7	33
4513-2.90-10P	7314150372171	10	1	2.9	61	2.9	33
4513-3.00-10P	7314150372188	10	1	3	61	3	33
4513-3.10-10P	7314150372195	10	1	3.1	65	3.1	36
4513-3.25-10P	7314150372201	10	1	3.25	65	3.25	36
4513-3.30-10P	7314150372218	10	1	3.3	65	3.3	36
4513-3.50-10P	7314150372225	10	1	3.5	70	3.5	39
4513-3.80-10P	7314150372232	10	1	3.8	75	3.8	43
4513-4.00-10P	7314150372249	10	1	4	75	4	43
4513-4.20-10P	7314150372256	10	1	4.2	75	4.2	43
4513-4.50-10P	7314150372263	10	1	4.5	80	4.5	47
4513-4.80-10P	7314150372270	10	1	4.8	86	4.8	52
4513-5.00-10P	7314150372287	10	1	5	86	5	52
4513-5.20-10P	7314150372294	10	1	5.2	86	5.2	52
4513-5.50-10P	7314150372300	10	1	5.5	93	5.5	57
4513-6.00-10P	7314150372317	10	1	6	93	6	57

				A	B	C	D
4513-6.20-10P	7314150372324	10	1	6.2	101	6.2	63
4513-6.50-10P	7314150372331	10	1	6.5	101	6.5	63
4513-6.80-10P	7314150372348	10	1	6.8	109	6.8	69
4513-7.00-10P	7314150372355	10	1	7	109	7	69
4513-7.20-10P	7314150372362	10	1	7.2	109	7.2	69
4513-7.50-10P	7314150372379	10	1	7.5	109	7.5	69
4513-7.80-10P	7314150372386	10	1	7.8	117	7.8	75
4513-8.00-10P	7314150372393	10	1	8	117	8	75
4513-8.50-10P	7314150372409	10	1	8.5	117	8.5	75
4513-8.60-10P	7314150372416	10	1	8.6	125	8.6	81
4513-8.80-10P	7314150372423	10	1	8.8	125	8.8	81
4513-9.00-10P	7314150372430	10	1	9	125	9	81
4513-9.20-10P	7314150372447	10	1	9.2	125	9.2	81
4513-9.50-10P	7314150372454	10	1	9.5	125	9.5	81
4513-9.60-10P	7314150372461	10	1	9.6	133	9.6	87
4513-10.00-5P	7314150391998	5	1	10	133	10	87
4513-10.20-5P	7314150392001	5	1	10.2	133	10.2	87
4513-10.30-5P	7314150392018	5	1	10.3	133	10.3	87
4513-10.50-5P	7314150392025	5	1	10.5	133	10.5	87
4513-10.80-5P	7314150392032	5	1	10.8	142	10.8	94
4513-11.00-5P	7314150392049	5	1	11	142	11	94

				A	B	C	D
4513-11.50-5P	7314150392056	5	1	11.5	142	11.5	94
4513-12.00-5P	7314150392063	5	1	12	151	12	101
4513-12.50-5P	7314150392070	5	1	12.5	151	12.5	101
4513-12.80-5P	7314150392087	5	1	12.8	151	12.8	101
4513-13.00-5P	7314150392094	5	1	13	151	13	101
4513-13.50-1P	7314150392100	1	1	13.5	160	13.5	108
4513-14.00-1P	7314150392117	1	1	14	160	14	108
4513-14.50-1P	7314150392124	1	1	14.5	169	14.5	114
4513-15.00-1P	7314150392131	1	1	15	169	15	114
4513-15.50-1P	7314150392148	1	1	15.5	169	15.5	

				A	B	C	D
4513-16.00-1P	7314150392155	1	1	16	178	16	120
4513-16.50-1P	7314150392162	1	1	16.5	184	16.5	125
4513-17.00-1P	7314150392179	1	1	17	184	17	125
4513-17.50-1P	7314150392186	1	1	17.5	191	17.5	130
4513-18.00-1P	7314150392193	1	1	18	191	18	130
4513-18.50-1P	7314150392209	1	1	18.5	198	18.5	135
4513-19.00-1P	7314150392216	1	1	19	198	19	135
4513-19.50-1P	7314150392223	1	1	19.5	205	19.5	140
4513-20.00-1P	7314150392230	1	1	20	205	20	140

## 4415

### HSS-R DRILLS FOR METAL

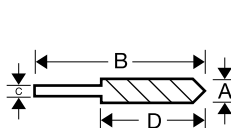









#### FEATURES:

- High-speed steel (HSS) drill for drilling in bronze, brass, carbon steel, cast iron, alloy steel and stainless steel
- Rolled flute with high elasticity and a low risk of breakage due to the manufacturing process
- Oxide coating reduces wear with good and rapid chip removal

- Drill bits have a cylindrical shank (shank equal to drill bit diameter) and are designed for use in drill stands and drill drivers
- Manufactured to DIN 338
- Size range 1mm to 13mm
- Size 1mm up to 4mm, two drills in each tube

#### ASSORTMENT:

				A	B	C	D
4415-1.00	7314150394210	2	1	1	34	1	12
4415-1.50	7314150394227	2	1	1.5	40	1.5	18
4415-2.00	7314150394234	2	1	2	49	2	24
4415-2.50	7314150394241	2	1	2.5	57	2.5	30
4415-3.00	7314150394258	2	1	3	61	3	33
4415-3.25	7314150394265	2	1	3.25	65	3.25	36
4415-3.50	7314150394272	2	1	3.5	70	3.5	39
4415-4.00	7314150394289	2	1	4	75	4	43
4415-4.25	7314150394296	1	1	4.25	75	4.25	43
4415-4.50	7314150394302	1	1	4.5	80	4.5	47
4415-5.00	7314150394319	1	1	5	86	5	52
4415-5.50	7314150394326	1	1	5.5	93	5.5	57

				A	B	C	D
4415-6.00	7314150394333	1	1	6	93	6	57
4415-6.50	7314150394340	1	1	6.5	101	6.5	63
4415-7.00	7314150394357	1	1	7	109	7	69
4415-7.50	7314150394364	1	1	7.5	109	7.5	69
4415-8.00	7314150394371	1	1	8	117	8	75
4415-8.50	7314150394388	1	1	8.5	117	8.5	75
4415-9.00	7314150394395	1	1	9	125	9	81
4415-10.00	7314150394401	1	1	10	133	10	87
4415-11.00	7314150394418	1	1	11	142	11	94
4415-12.00	7314150394425	1	1	12	151	12	101
4415-13.00	7314150394432	1	1	13	151	13	101

4513-SET-19 / 25

## HSS-G DRILL SET FOR METAL - 19 / 25 PCS



### FEATURES:

- High-speed steel (HSS) drill for bronze, brass, carbon steel, cast iron, alloy steel and stainless steel
- Ground flutes enable fast drilling and high precision
- Top angle of 130° with self-centring split-point tip for quick cutting and perfect centring
- Speed Point, no need to pre-punch or pilot drill up to 10mm diameter
- Drill bits have a cylindrical shank (shank equal to drill bit diameter) designed for use in drill stands and drivers
- Manufactured to DIN 338 N
- Size range 0.5 to 20mm
- Contains 19 or 25 drills from 1.0mm to 10.0mm x 0.5mm in a plastic case

### ASSORTMENT:

4513-SET-19	7314150372096	1	19	600
4513-SET-25	7314150372102	1	25	1300

4515-SET-19

## HSS-R DRILL SET FOR METAL - 19 PCS



### FEATURES:

- High-speed steel (HSS) drill for bronze, brass, carbon steel, cast iron, alloy steel and stainless steel
- Rolled flute with high elasticity and a low risk of breakage due to the manufacturing process
- Oxide coating reduces wear with good and rapid chip removal
- Drill bits have a cylindrical shank (shank equal to drill bit diameter) designed for use in drill stands and drivers
- Manufactured to DIN 338
- Contains 19 drills from 1.0mm to 10.0mm x 0.5mm in a plastic case

### ASSORTMENT:

4515-SET-19	7314150394449	1	19	600

4513-SET-6

## HSS-G DRILL SET FOR METAL - 6 PCS



### FEATURES:

- High-speed steel (HSS) drill for bronze, brass, carbon steel, cast iron, alloy steel and stainless steel
- Ground flutes enable fast drilling and high precision
- Top angle of 130° with self-centring split-point tip for quick cutting and perfect centring
- Speed Point, no need to pre-punch or pilot drill up to 10mm diameter
- Drill bits have a cylindrical shank (shank equal to drill bit diameter) designed for use in drill stands and drivers
- Manufactured to DIN 338 N
- Contains 6 drills from 2.0mm to 8.0mm x 1.0mm (excl. 7.0mm) in a plastic cassette

### ASSORTMENT:

4513-SET-6	7314150372089	1	6	130

4511-SET-19

## COBALT HSS-E DRILL SET FOR METAL - 19 PCS



### FEATURES:

- The Cobalt High-speed steel (HSS) provides long lasting high performance when drilling in stainless steel materials
- Cobalt drills work effectively with alloyed and non-alloyed steel, stainless steel, cast iron, cast steel and acid and heat-resistant steels
- Ground flutes enable fast drilling and high precision
- Top angle of 135° with self-centring split-point tip for quick cutting and perfect centring
- Speed Point, no need to pre-punch or pilot drill up to 10mm diameter
- Drill bits have a cylindrical shank (shank equal to drill bit diameter) designed for use in drill stands and drivers
- Manufactured to DIN 338 N
- Size range 0.5mm to 20mm
- Contains 19 drills from 1.0mm to 10.0mm x 0.5mm in a plastic case

### ASSORTMENT:

4511-SET-19	7314150373031	1	19	600

**4511-SET-25****COBALT HSS-E DRILL SET  
FOR METAL - 25 PCS****FEATURES:**

- The Cobalt High-speed steel (HSS) provides long-lasting high performance when drilling in stainless steel materials
- Cobalt drills work effectively with alloyed and non-alloyed steel, stainless steel, cast iron, cast steel and acid and heat-resistant steels
- Ground flutes enable fast drilling and high precision
- Top angle of 135° with self-centring split-point tip for quick cutting and perfect centring
- Speed Point, no need to pre-punch or pilot drill up to 10mm diameter
- Drill bits have a cylindrical shank (shank equal to drill bit diameter) designed for use in drill stands and drivers
- Manufactured to DIN 338 N
- Size range 0.5mm to 20mm
- Contains 25 drills from 1.0mm to 13.0mm x 0.5mm in a plastic case

**ASSORTMENT:**

4511-SET-25	7314150373048	1	25	1300

**4511-SET-6****COBALT HSS-E DRILL SET  
FOR METAL - 6 PCS****FEATURES:**

- The Cobalt High-speed steel (HSS) provides long-lasting high performance when drilling in stainless steel materials
- Cobalt drills work effectively with alloyed and non-alloyed steel, stainless steel, cast iron, cast steel and acid and heat-resistant steels
- Ground flutes enable fast drilling and high precision
- Top angle of 135° with self-centring split-point tip for quick cutting and perfect centring
- Speed Point, no need to pre-punch or pilot drill up to 10mm diameter
- Drill bits have a cylindrical shank (shank equal to drill bit diameter) and are designed for use in drill stands and drivers
- Manufactured to DIN 338 N
- Size range 0.5mm to 20mm
- Contains 6 drills from 2.0 to 8.0mm x 1.0mm (excl. 7.0mm) in a plastic cassette

**ASSORTMENT:**

4511-SET-6	7314150373024	1	6	130

# STEP DRILL BITS

5 PRODUCTS

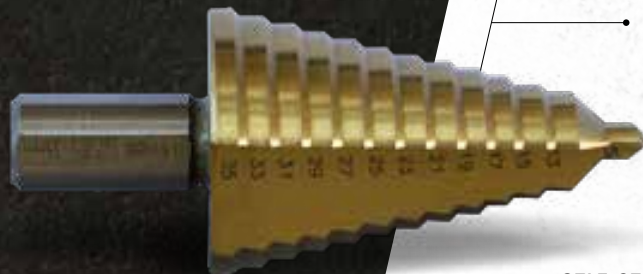

5x

LASTS UP TO FIVE TIMES LONGER THAN ORDINARY STEP DRILL BITS

TITANIUM-NITRIDE (TiN) COATING WITH A SURFACE HARDNESS

SELF-LUBRICATES WHILE RUNNING DRY



SELF-CENTRING POINT

LASTS UP TO 5 TIMES LONGER!

228-SD

## STEP DRILL - 4 TO 12 MM

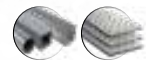
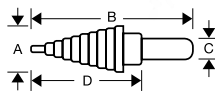

### FEATURES:

- For making holes in thin metal sheets
- Titanium-nitride-coated step drill with a surface hardness that makes the tool last 4 to 5 times longer than ordinary step drill bits. That same surface reduces friction, resulting

in a tool that runs cooler and, in effect, self-lubricates while running dry

- Drills holes from 4 to 12 mm in 1 mm increments
- Shank 1/4" (6 mm)

### ASSORTMENT:

				A	B	C	D	
228-SD	7311518277048	1	24	4-5-6-7-8-9-10-11-12	76	6	40	70

229-SD

## STEP DRILL - 4 TO 22 MM

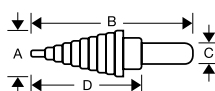

### ASSORTMENT:

				A	B	C	D	
229-SD	7311518277055	1	24	4-6-8-10-12-14-16-18-20-22	76	6	40	70

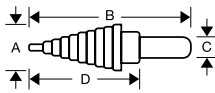
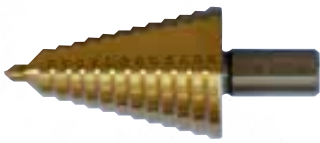

**230-SD****STEP DRILL - 5 TO 35 MM****ASSORTMENT:**

				A	B	C	D	
230-SD	7311518280956	1	1	5-13-15-17-19-21-23-25-27-29-31-33-35	83	12,7	58	175

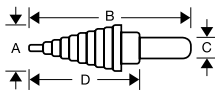
**232-SD****STEP DRILL - 6 TO 37 MM****ASSORTMENT:**

				A	B	C	D	
232-SD	7314150214839	1	1	6-9-12.5-15.2-18.6-20.4-22.5-26-28.3-30.5-34-37	100	10	75	300

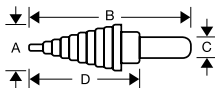
**234-SD****STEP DRILL - 6.5 TO 40.5 MM****ASSORTMENT:**

				A	B	C	D	
234-SD	7314150214846	1	1	6.5-8.5-10.5-12.5-16.5-20.5-25.5-29-32.5-36.5-40.5	96	10	71	300

**228-SET-SD****HSS STEP DRILLS SET - 3 PCS****FEATURES:**

- For making holes in thin metal sheets
- Titanium-nitride-coated step drill with a surface hardness that makes the tool last 4 to 5 times longer than an ordinary step drill bit
- 3 piece HSS step drill set contents 4 to 12 mm in 1 mm increments
- 4 to 22 mm in 2 mm increments
- 5 to 35 mm in 2 mm increments

**ASSORTMENT:**

228-SET-SD	7314150217946	1	1	560

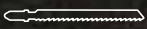
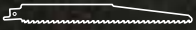

687

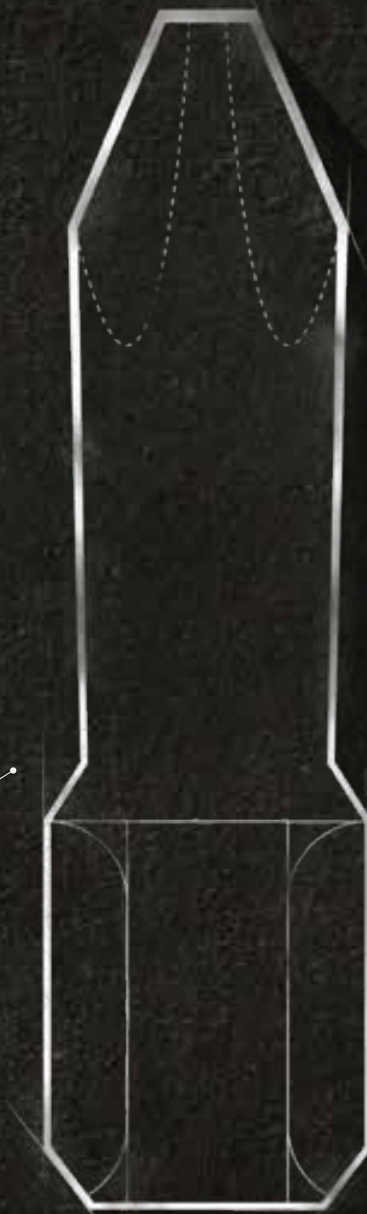



# SCREWDRIVER BITS

**687**  
PRODUCTS

## PRODUCT INDEX

<i>DIAMOND SCREWDRIVER BITS</i>	128
<i>TIN TORSION SCREWDRIVER BITS</i>	130
<i>ACR TORSION SCREWDRIVER BITS</i>	132
<i>TORSION SCREWDRIVER BITS</i>	133
<i>EXTRA HARD TORSION SCREWDRIVER BITS</i>	136
<i>STAINLESS STEEL TORSION SCREWDRIVER BITS</i>	138
<i>STANDARD SCREWDRIVER BITS</i>	140
<i>SCREWDRIVER BIT HOLDERS, POWER NUT DRIVERS AND ADAPTORS</i>	158

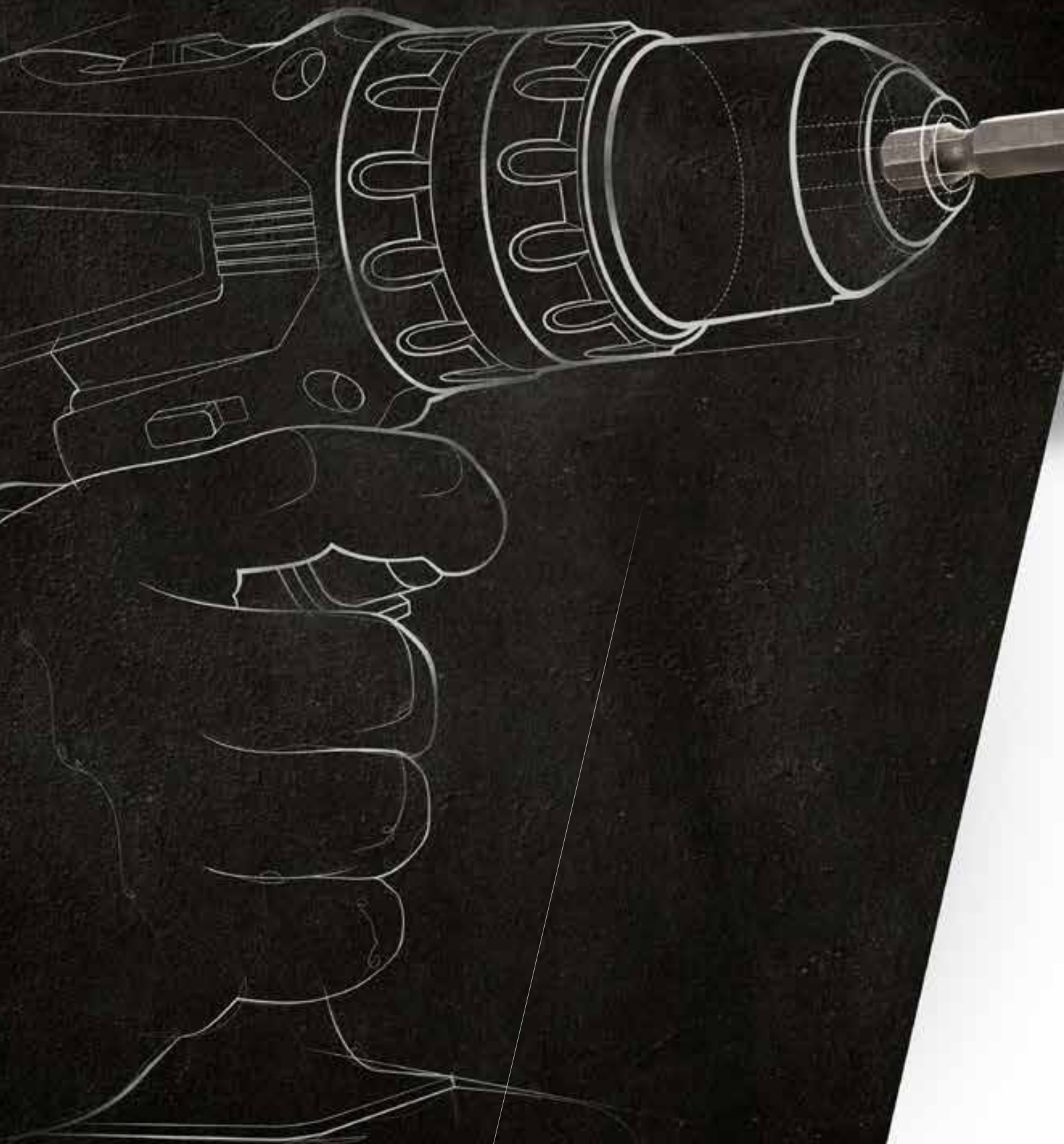

687

# **ESSENTIAL, QUALITY** **SCREWDRIVER BITS** **FOR PROFESSIONALS**

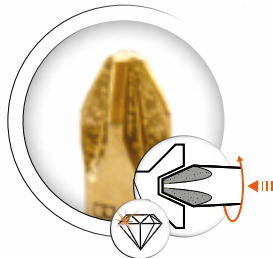

**ULTIMATE GRIP WITH OUR DIAMOND-COATED  
SCREWDRIVER BITS. IMPROVE PRODUCTIVITY  
AND SAVE MONEY**

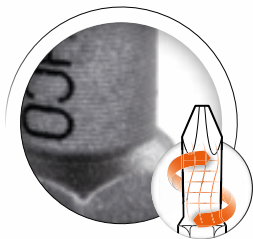

**NO MORE TORQUE PEAKS! THE TORSION ZONE  
ABSORBS IT AND PREVENTS THE SCREWDRIVER  
BIT (AND SCREW) FROM BREAKING**

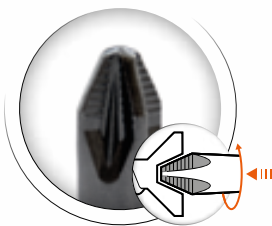

**ACR® SCREWDRIVER BITS ARE SPECIALLY  
MADE FOR TASKS WHERE YOU NEED TO  
REDUCE THE CAM-OUT EFFECT**

# FULL OF POWER

**We offer you a wide range of screwdriver bits, with a choice of features to suit any application. Bits that make a difference! Bahco Screwdriver Bits are made of high-performance steel alloy and give you the top quality and long service life you're looking for as a professional.**

You can choose from all kinds of profiles and drives, such as slotted, Phillips, Pozidriv, TORX®, TORX® Tamper, HEX, Robertson®, XZN, Tri-wing and TORQ-SET®.

Bahco meets professional demands by providing the appropriate quality levels: Standard, Torsion, Extra Hard Torsion, INOX Torsion, Stainless Steel, TiN Torsion, ACR Torsion and Diamond Torsion Screwdriver Bits.

## FULL SUPPORT

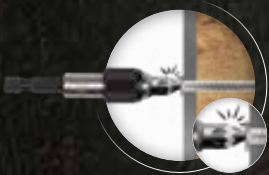

### TORQUE PEAKS

When using a machine, bits and screws can be submitted to very high torque peaks which cause wear on both bit and screw but can also lead to breakage.



### CAM-OUT-EFFECT

The Cam-Out effect is a common problem with conventional screwdriver bits. The cam-out force causes the bit to slip out of the screw head and possibly damages the screwhead or screwdriver bit.



### INNOVATIVE TORSION ZONE

All Bahco special screwdriver bits have a Torsion zone (extended bar) that absorbs torque peaks, avoiding premature wear and prolonging service life. Nucleus Hardness: 62-64 HRC.

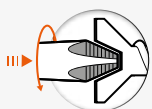

### ANTI-CAM-OUT-EFFECT

Conventional screwdriver bits easily slip out of the head of the screw. Avoid this cam-out with ACR® bits. The Anti-Cam-out-Ribs lock themselves into the screw and provide strong grip.

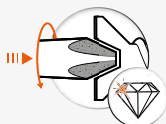

















### DIAMOND COATING

Our diamond screwdriver bits are tip coated with thousands of industrial-grade diamond particles. This significantly reduces the cam-out effect and provides ultimate and safe grip.

# FULL RANGE

687 PRODUCTS

	<b>DIAMOND SCREWDRIVER BITS</b>	<b>TIN TORSION SCREWDRIVER BITS</b>	<b>ACR® TORSION SCREWDRIVER BITS</b>	<b>TORSION SCREWDRIVER BITS</b>
<b>Range</b>	 25-50 mm	 25-50 mm	 25 mm	 25 mm
<b>Screw heads</b>				
<b>Sets</b>	✓	✓		✓
<b>Application</b>	High performance in any application	High volume production and continuous use	For tasks requiring reduction of the "cam-out" effect	Hard material applications
	<b>EXTRA HARD TORSION SCREWDRIVER BITS</b>	<b>STAINLESS STEEL TORSION SCREWDRIVER BITS</b>	<b>STANDARD SCREWDRIVER BITS</b>	<b>IMPACT SCREWDRIVER BITS</b>
<b>Range</b>	 25-50 mm	 25-50 mm	 25-150 mm	 25 mm
<b>Screw heads</b>				
<b>Sets</b>		✓	✓	✓
<b>Application</b>	Suitable for wood and soft material applications	Ideal for use on stainless steel screws	For all screw applications in trade and industry	For withstanding high power tool forces

## SCREWDRIVER BIT HOLDERS, POWER NUT DRIVERS AND ADAPTORS

**TORSION SCREWDRIVER BIT HOLDER**



COMING SOON!

**QUICK-RELEASE SCREWDRIVER BIT HOLDER**



**UNIVERSAL SCREWDRIVER BIT HOLDER**



**SOCKET ADAPTORS**



**NUT DRIVERS**



# DIAMOND SCREWDRIVER BITS

33 PRODUCTS

ULTIMATE GRIP WITH  
OUR DIAMOND-COATED  
SCREWDRIVER BITS



TIP COATED WITH THOUSANDS OF INDUSTRIAL-GRADE DIAMOND PARTICLES

FITS MOST COMMON SCREW HEADS, SUCH AS PHILLIPS, POZIDRIV AND TORX®



HIGH PERFORMANCE FOR ANY JOB

CORE HARDNESS 60-62 HRC

SAFE GRIP AND SIGNIFICANTLY REDUCES THE CAM-OUT EFFECT

ABSORBS THE TORQUE PEAKS USING AN INNOVATIVE TORSION ZONE - LESS RISK OF THE SCREW OR BIT BREAKING

## DIAMOND SCREWDRIVER BITS - 25 MM



### FEATURES:

- Drive: 1/4" DIN 3126-C 6,3, ISO 1173
- Finish: Gold-coloured diamond coating
- Material: High-performance alloy steel
- Reduces wear on the bit and screw
- Diamond coating for a secure fit in the screw to minimise the cam-out effect reducing the 'down-time'
- Application: High performance in any application suitable for power tools
- Torsion zone that absorbs torque peaks avoiding premature wear and tear and improving service life

### ASSORTMENT:

#### 63D/PH | DIAMOND SCREWDRIVER BITS PHILLIPS - 25 MM

Icon	Barcode	X	Y	Drive	Length	Weight
63D/PH1-2P	7314150201051	2	1	PH1	25	10
63D/PH2-2P	7314150201068	2	1	PH2	25	15
63D/PH3-2P	7314150262342	2	1	PH3	25	31

Icon	Barcode	X	Y	Drive	Length	Weight
63D/PH1	7314150198917	5	1	PH1	25	25
63D/PH2	7314150198931	5	1	PH2	25	25
63D/PH3	7314150198948	5	1	PH3	25	25







#### 63D/PH2G | DIAMOND SCREWDRIVER BITS GRABBER PHILLIPS - 25 MM

Icon	Barcode	X	Y	Drive	Length	Weight
63D/PH2G-2P	7314150201075	2	1	PH2G	25	15







Icon	Barcode	X	Y	Drive	Length	Weight
63D/PH2G	7314150198979	5	1	PH2G	25	25



## **63D/PZ** | DIAMOND SCREWDRIVER BITS POZIDRIV - 25 MM

						
63D/PZ1-2P	7314150201037	2	1	PZ1	25	10
63D/PZ2-2P	7314150201044	2	1	PZ2	25	15
63D/PZ3-2P	7314150262335	2	1	PZ3	25	31

## **63D/T** | DIAMOND SCREWDRIVER BITS TORX® - 25 MM







						
63D/T10-2P	7314150262304	2	1	T10	25	10
63D/T15-2P	7314150201006	2	1	T15	25	15
63D/T20-2P	7314150201013	2	1	T20	25	15
63D/T25-2P	7314150201020	2	1	T25	25	15
63D/T30-2P	7314150262311	2	1	T30	25	17
63D/T40-2P	7314150262328	2	1	T40	25	17

## **DIAMOND SCREWDRIVER BITS - 50 MM**









### ASSORTMENT:

## **63D/50PH** | DIAMOND SCREWDRIVER BITS PHILLIPS - 50 MM

						
63D/50PH1	7314150200351	5	1	PH1	50	40
63D/50PH2	7314150200368	5	1	PH2	50	40

## **63D/50PZ** | DIAMOND SCREWDRIVER BITS POZIDRIV - 50 MM

						
63D/50PZ1	7314150200320	5	1	PZ1	50	40
63D/50PZ2	7314150200337	5	1	PZ2	50	40

### 63D/7

## **DIAMOND SCREWDRIVER BIT SET - 7 PCS**



### FEATURES:









- 7 pcs bit set: 6 diamond bits and 1 universal bit holder
- In a hanging cardboard sleeve
- Drive: 1/4" DIN 3126-C6.3, ISO 1173
- Finish: Diamond coating
- Material: High-performance alloy steel

- Tip coated with thousands of tiny industrial-grade diamond particles. Diamond bit has high strength and good wear resistance. Reduces significantly the "cam-out" effect and the necessary torque required to successfully drive the screw

### ASSORTMENT:

							
63D/7-1	7314150191604	7	1	80	50	20	155

### SET CONTAINS:

63D/PH2		
63D/PZ2		
63D/T10, 63D/T15, 63D/T25, 63D/T30		
1/4"- 50 mm		

# TIN TORSION SCREWDRIVER BITS

37 PRODUCTS

**ABRASION-PROOF COATING  
TO GIVE HARDNESS  
FOR MASS-PRODUCTION**



COATED WITH EXTREMELY  
HARD TITANIUM NITRIDE (TIN)

FITS MOST COMMON SCREW  
HEADS, SUCH AS PHILLIPS,  
POZIDRIV AND TORX®



MADE FOR MASS PRODUCTION AND  
OTHER HIGH-DEMAND APPLICATIONS

CORE HARDNESS 60-62 HRC

INNOVATIVE TORSION ZONE - LESS  
RISK OF BREAKAGES

## TIN TORSION SCREWDRIVER BITS - 25 MM



### FEATURES:

- Drive: 1/4" DIN 3126-C6.3, ISO 1173
- Finish: Titanium nitride
- Material: High-performance alloy steel

- Application: TIN bits are extremely wear resistant when used for high-volume production and continuous use
- Torsion zone absorbs torque peaks avoiding premature wear and tear and improving service life

### ASSORTMENT:

#### 62TIN/PH | TIN TORSION SCREWDRIVER BITS PHILLIPS - 25 MM

Icon	Barcode	Quantity	Length	Drive	Length	Weight
62TIN/PH1-2P	7314150262083	2	1	PH1	25	13
62TIN/PH2-2P	7314150262090	2	1	PH2	25	14
62TIN/PH3-2P	7314150262106	2	1	PH3	25	15

Icon	Barcode	Quantity	Length	Drive	Length	Weight
62TIN/PH1	7314150199259	10	1	PH1	25	40
62TIN/PH2	7314150199297	10	1	PH2	25	40
62TIN/PH3	7314150199303	10	1	PH3	25	40

#### 62TIN/PZ | TIN TORSION SCREWDRIVER BITS POZIDRIV - 25 MM

Icon	Barcode	Quantity	Length	Drive	Length	Weight
62TIN/PZ1-2P	7314150201105	2	1	PZ1	25	10
62TIN/PZ2-2P	7314150201112	2	1	PZ2	25	15
62TIN/PZ3-2P	7314150201129	2	1	PZ3	25	15

Icon	Barcode	Quantity	Length	Drive	Length	Weight
62TIN/PZ1	7314150199327	10	1	PZ1	25	40
62TIN/PZ2	7314150199334	10	1	PZ2	25	40
62TIN/PZ3	7314150199358	10	1	PZ3	25	40

## ★ 62TIN/T | TIN TORSION SCREWDRIVER BITS TORX® - 25 MM

Icon	Barcode	Box	Case	Star	Length	Weight	Icon	Barcode	Box	Case	Star	Length	Weight		
	62TIN/T10-2P	7314150262113	2	1	T10	25	13		62TIN/T10	7314150199372	10	1	T10	25	40
	62TIN/T15-2P	7314150262144	2	1	T15	25	13		62TIN/T15	7314150199402	10	1	T15	25	40
	62TIN/T20-2P	7314150262168	2	1	T20	25	14		62TIN/T20	7314150199426	10	1	T20	25	40
	62TIN/T25-2P	7314150262212	2	1	T25	25	14		62TIN/T25	7314150199440	10	1	T25	25	40
	62TIN/T30-2P	7314150262229	2	1	T30	25	15		62TIN/T30	7314150199464	10	1	T30	25	40
	62TIN/T40-2P	7314150262236	2	1	T40	25	20		62TIN/T40	7314150199471	10	1	T40	25	50

## TIN TORSION SCREWDRIVER BITS - 50 MM



### ASSORTMENT:

## ★ 62TIN/50PH | TIN TORSION SCREWDRIVER BITS PHILLIPS - 50 MM

Icon	Barcode	Box	Case	Star	Length	Weight	Icon	Barcode	Box	Case	Star	Length	Weight		
	62TIN/50PH1-2P	7314150262243	2	1	PH1	50	26		62TIN/50PH1	7314150200504	5	1	PH1	50	50
	62TIN/50PH2-2P	7314150262250	2	1	PH2	50	28		62TIN/50PH2	7314150200511	5	1	PH2	50	50
	62TIN/50PH3-2P	7314150262267	2	1	PH3	50	30		62TIN/50PH3	7314150200528	5	1	PH3	50	50

## ★ 62TIN/50PZ | TIN TORSION SCREWDRIVER BITS POZIDRIV - 50 MM

Icon	Barcode	Box	Case	Star	Length	Weight	Icon	Barcode	Box	Case	Star	Length	Weight		
	62TIN/50PZ1-2P	7314150262274	2	1	PZ1	50	26		62TIN/50PZ1	7314150200535	5	1	PZ1	50	50
	62TIN/50PZ2-2P	7314150262281	2	1	PZ2	50	28		62TIN/50PZ2	7314150200542	5	1	PZ2	50	50
	62TIN/50PZ3-2P	7314150262281	2	1	PZ3	50	28		62TIN/50PZ3	7314150200559	5	1	PZ3	50	50

## 62TIN/7

## TIN TORSION SCREWDRIVER BIT SET - 7 PCS



### FEATURES:

- 7 pcs bit set: 6 tin bits and 1 universal bit holder
- In a hanging cardboard sleeve
- Drive: 1/4" DIN 3126-C6.3, ISO 1173
- Finish: Titanium nitride

- Material: High-performance alloy steel
- TIN bits are extremely wear resistant when used for high-volume production and continuous use at normal torque levels

### ASSORTMENT:

Icon	Barcode	Box	Case	Star	Length	Weight		
	62TIN/7-1	7314150203505	7	1	75	65	22	105

### SET CONTAINS:

62TIN/PH2	
62TIN/PZ2	
62TIN/T15, 62TIN/T20, 62TIN/T25, 62TIN/T30	
1/4" - 50 mm	

# ACR TORSION SCREWDRIVER BITS

12 PRODUCTS

**ACR®: TOUGHNESS AND  
LESS CAM-OUT EFFECT**



• SCREW HEAD WITH "ANTI-CAM-OUT-RIBS" – THE ACR® SYSTEM

• FITS MOST COMMON  
SCREW HEADS, SUCH AS  
PHILLIPS AND POZIDRIV



• SPECIALLY MADE FOR JOBS  
WHERE YOU WANT TO REDUCE  
THE CAM-OUT EFFECT

• CORE HARDNESS 60-62 HRC

• SURFACE COATED WITH CLEAR  
LACQUER FOR RUST PROTECTION

• INNOVATIVE TORSION ZONE  
ABSORBS THE TORQUE PEAKS  
– LESS RISK OF BREAKAGES

## ACR TORSION SCREWDRIVER BITS - 25 MM



### FEATURES:

- Drive: 1/4" DIN 3126-C6.3, ISO 1173
- Surface coated with clear lacquer for rust protection

- Material: High-performance alloy steel, ideal for bits
- Application: Recommended for tasks requiring reduction of the "cam-out" effect, avoiding the erosion of the bit-screws

### ASSORTMENT:

#### 64A/PH | ACR TORSION SCREWDRIVER BITS PHILLIPS - 25 MM

Icon	Barcode	Icon X	Icon	Icon	Icon	Icon g
64A/PH1-2P	7314150200948	2	1	PH1	25	10
64A/PH2-2P	7314150200955	2	1	PH2	25	15
64A/PH3-2P	7314150200962	2	1	PH3	25	15

Icon	Barcode	Icon X	Icon	Icon	Icon	Icon g
64A/PH1	7314150198481	10	1	PH1	25	50
64A/PH2	7314150198559	10	1	PH2	25	50
64A/PH3	7314150198573	10	1	PH3	25	50

#### 64A/PZ | ACR TORSION SCREWDRIVER BITS POZIDRIV - 25 MM

Icon	Barcode	Icon X	Icon	Icon	Icon	Icon g
64A/PZ1-2P	7314150200979	2	1	PZ1	25	10
64A/PZ2-2P	7314150200986	2	1	PZ2	25	15
64A/PZ3-2P	7314150200993	2	1	PZ3	25	15

Icon	Barcode	Icon X	Icon	Icon	Icon	Icon g
64A/PZ1	7314150198603	10	1	PZ1	25	50
64A/PZ2	7314150198627	10	1	PZ2	25	50
64A/PZ3	7314150198634	10	1	PZ3	25	50

# TORSION SCREWDRIVER BITS

31 PRODUCTS

SCREWDRIVER BITS WITH  
INNOVATIVE TORSION ZONE  
FOR HARD MATERIALS



SUITABLE FOR HARD MATERIAL  
APPLICATIONS IN MANY  
DIFFERENT ENVIRONMENTS

FITS MOST COMMON SCREW  
HEADS, SUCH AS PHILLIPS,  
POZIDRIV AND TORX®



CORE HARDNESS 60-62 HRC

STEEL SURFACE-COATED  
WITH CLEAR LACQUER FOR  
RUST PROTECTION



ABSORBS THE TORQUE PEAKS  
USING AN INNOVATIVE TORSION  
ZONE - LESS RISK OF THE SCREW  
OR SCREWDRIVER BIT BREAKING

## TORSION SCREWDRIVER BITS - 25 MM



### FEATURES:

- Drive: 1/4" DIN 3126-C6.3, ISO 1173
- Finish: Steel surface coated with clear lacquer for rust protection
- Material: High-performance alloy steel
- Application: Torsion bits are suitable for hard material applications

- A softer bit is more wear resistant against sudden impacts (in hard materials), preventing the tip from breaking prematurely
- Surface-coated with clear lacquer for rust protection
- Torsion zone that absorbs torque peaks avoiding premature wear and tear and improving service life

### ASSORTMENT:

#### 60T/PH | TORSION SCREWDRIVER BITS PHILLIPS - 25 MM

Part No.	Barcode	Box Qty	Pack Qty	Head Type	Length (mm)	Weight (g)
60T/PH1-2P	7314150201136	2	1	PH1	25	10
60T/PH2-2P	7314150201143	2	1	PH2	25	15
60T/PH3-2P	7314150201150	2	1	PH3	25	15

Part No.	Barcode	Box Qty	Pack Qty	Head Type	Length (mm)	Weight (g)
60T/PH1	7314150199488	10	1	PH1	25	40
60T/PH2	7314150199495	10	1	PH2	25	40
60T/PH3	7314150199501	10	1	PH3	25	60

#### 60T/PZ | TORSION SCREWDRIVER BITS POZIDRIV - 25 MM

Part No.	Barcode	Box Qty	Pack Qty	Head Type	Length (mm)	Weight (g)
60T/PZ1-2P	7314150201167	2	1	PZ1	25	10
60T/PZ2-2P	7314150201174	2	1	PZ2	25	15
60T/PZ3-2P	7314150201181	2	1	PZ3	25	15

Part No.	Barcode	Box Qty	Pack Qty	Head Type	Length (mm)	Weight (g)
60T/PZ1	7314150199525	10	1	PZ1	25	45
60T/PZ2	7314150199549	10	1	PZ2	25	50
60T/PZ3	7314150199563	10	1	PZ3	25	50

**60T/T | TORSION SCREWDRIVER BITS TORX® - 25 MM**

60T/T10-2P	7314150201198	2	1	T10	25	10
60T/T15-2P	7314150201204	2	1	T15	25	10
60T/T20-2P	7314150201211	2	1	T20	25	15
60T/T25-2P	7314150201228	2	1	T25	25	15
60T/T30-2P	7314150201235	2	1	T30	25	15
60T/T40-2P	7314150201242	2	1	T40	25	15
60T/T7	7314150199587	10	1	T7	25	40
60T/T8	7314150199600	10	1	T8	25	40

60T/T9	7314150199624	10	1	T9	25	40
60T/T10	7314150199648	10	1	T10	25	40
60T/T15	7314150199662	10	1	T15	25	40
60T/T20	7314150199686	10	1	T20	25	40
60T/T25	7314150199709	10	1	T25	25	40
60T/T27	7314150199723	10	1	T27	25	40
60T/T30	7314150199747	10	1	T30	25	40
60T/T40	7314150199761	10	1	T40	25	40

**60T/7  
TORSION SCREWDRIVER BIT SET - 7 PCS**



**FEATURES:**

- 7 pcs bit set: 6 torsion bits and 1 universal bit holder
- In a hanging cardboard card
- Drive: 1/4" DIN 3126-C6.3, ISO 1173

- Finish: Zinc phosphate
- Material: High-performance alloy steel, ideal for bits
- Torsion bits are suitable for hard material applications

**ASSORTMENT:**

60T/7-1	7314150191574	7	1	75	65	22	105	

**SET CONTAINS:**

60T/PH2		
60T/PZ2		
60T/T10, 60T/T15, 60T/T20, 60T/T30		
1/4"- 50 mm		

**60T/17  
TORSION SCREWDRIVER BIT SET - 17 PCS**



**FEATURES:**

- 17 pcs bit set: 16 bits and 1 magnetic quick-release bit holder
- Drive: 1/4" DIN 3126-C6.3, ISO 1173

- Finish: Zinc phosphate
- Material: High-performance alloy steel
- Torsion bits are suitable for hard material applications

**ASSORTMENT:**

60T/17-1	7314150191529	17	1	82	73	27	130	

**SET CONTAINS:**

60T/PH1, PH2		
60T/T7, T8, T9, T10, 2xT15, 2xT20, 2xT25, T27, 2xT30, T40		
1/4"- 50 mm		

60T/31

## TORSION SCREWDRIVER BIT SET - 31 PCS



### FEATURES:

- 31 pcs bit set: 30 (Torsion+Original) bits and 1 magnetic quick-release bit holder
- In hanging cardboard packaging
- Drive: 1/4" DIN 3126-C6.3, ISO 1173

- Finish: Zinc phosphate
- Material: High-performance alloy steel
- Torsion bits are suitable for hard material applications

### ASSORTMENT:

60T/31-1	7314150191482	31	1	110	65	42	245	

### SET CONTAINS:

60T/0.6x4.5, 0.8x5.5 mm		
60T/PH1, 3xPH2, PH3, 2xPH2G		
60T/PZ1, 3xPZ2, PZ3		
60T/T10, 3xT15, 3xT20, 2xT25, T27, 2xT30		
60T/H3.0, 4.0, 5.0, 6.0		
1/4"- 60 mm		

# EXTRA HARD TORSION SCREWDRIVER BITS

48 PRODUCTS

EXTRA HARD TORSION  
SCREWDRIVER BITS FOR  
SOFT MATERIALS



SUITABLE FOR WOOD  
AND SOFT MATERIALS

FITS MOST COMMON SCREW  
HEADS, SUCH AS PHILLIPS,  
POZIDRIV AND TORX®



STEEL SURFACE-COATED  
FOR RUST PROTECTION

INNOVATIVE TORSION ZONE  
- LESS RISK OF BREAKAGES

## EXTRA HARD TORSION SCREWDRIVER BITS - 25 MM



### FEATURES:

- Drive: 1/4" DIN 3126-C6.3, ISO 1173
- Finish: Surface coated for rust protection
- Material: High-performance alloy steel, ideal for bits
- Application: Extra hard bits are suitable for wood and soft material applications

- Suitable for wood and soft material applications
- Extra hard bits are subject to special heating processes that make them harder and reduce the risk of the breakage
- Surface-coated with clear lacquer for rust protection
- Torsion zone that absorbs torque peaks avoiding premature wear and tear and improving service life

### ASSORTMENT:

#### 61H/PH | EXTRA HARD TORSION SCREWDRIVER BITS PHILLIPS - 25 MM

Part No.	Barcode	Box Qty	Blister Qty	Drive	Length (mm)	Weight (g)
61H/PH1-2P	7314150261840	2	1	PH1	25	13
61H/PH2-2P	7314150201082	2	1	PH2	25	15
61H/PH3-2P	7314150261857	2	1	PH3	25	15

Part No.	Barcode	Box Qty	Blister Qty	Drive	Length (mm)	Weight (g)
61H/PH1	7314150199006	10	1	PH1	25	40
61H/PH2	7314150199020	10	1	PH2	25	40
61H/PH3	7314150199044	5	1	PH3	25	25

#### 61H/PZ | EXTRA HARD TORSION SCREWDRIVER BITS POZIDRIV - 25 MM

Part No.	Barcode	Box Qty	Blister Qty	Drive	Length (mm)	Weight (g)
61H/PZ1-2P	7314150261888	2	1	PZ1	25	13
61H/PZ2-2P	7314150201099	2	1	PZ2	25	15
61H/PZ3-2P	7314150261895	2	1	PZ3	25	15

Part No.	Barcode	Box Qty	Blister Qty	Drive	Length (mm)	Weight (g)
61H/PZ1	7314150199068	10	1	PZ1	25	40
61H/PZ2	7314150199082	10	1	PZ2	25	40
61H/PZ3	7314150199105	5	1	PZ3	25	25



**★ 61H/T | EXTRA HARD TORSION SCREWDRIVER BITS TORX® - 25 MM**

61H/T10-2P		7314150261901	2	1	T10	25	13
61H/T15-2P		7314150261918	2	1	T15	25	13
61H/T20-2P		7314150261925	2	1	T20	25	14
61H/T25-2P		7314150261932	2	1	T25	25	14
61H/T30-2P		7314150261949	2	1	T30	25	15
61H/T40-2P		7314150261956	2	1	T40	25	17

61H/T10		7314150199129	10	1	T10	25	40
61H/T15		7314150199143	10	1	T15	25	40
61H/T20		7314150199167	10	1	T20	25	40
61H/T25		7314150199181	10	1	T25	25	40
61H/T30		7314150199211	10	1	T30	25	40
61H/T40		7314150199235	5	1	T40	25	30

**EXTRA HARD TORSION SCREWDRIVER BITS - 50 MM**



**ASSORTMENT:**

**★ 61H/50PH | EXTRA HARD TORSION SCREWDRIVER BITS PHILLIPS - 50 MM**

61H/50PH1-2P		7314150261963	2	1	PH1	50	25
61H/50PH2-2P		7314150261970	2	1	PH2	50	26
61H/50PH3-2P		7314150261987	2	1	PH3	50	30

61H/50PH1		7314150200382	5	1	PH1	50	40
61H/50PH2		7314150200399	5	1	PH2	50	40
61H/50PH3		7314150200405	5	1	PH3	50	40

**★ 61H/50PZ | EXTRA HARD TORSION SCREWDRIVER BITS POZIDRIV - 50 MM**

61H/50PZ1-2P		7314150261994	2	1	PZ1	50	25
61H/50PZ2-2P		7314150262007	2	1	PZ2	50	26
61H/50PZ3-2P		7314150262014	2	1	PZ3	50	30

61H/50PZ1		7314150200412	5	1	PZ1	50	40
61H/50PZ2		7314150200429	5	1	PZ2	50	40
61H/50PZ3		7314150200436	5	1	PZ3	50	40

**★ 61H/50T | EXTRA HARD TORSION SCREWDRIVER BITS TORX® - 50 MM**

61H/50T10-2P		7314150262021	2	1	T10	50	25
61H/50T15-2P		7314150262038	2	1	T15	50	25
61H/50T20-2P		7314150262045	2	1	T20	50	28
61H/50T25-2P		7314150262052	2	1	T25	50	28
61H/50T30-2P		7314150262069	2	1	T30	50	30
61H/50T40-2P		7314150262076	2	1	T40	50	40

61H/50T10		7314150200443	5	1	T10	50	40
61H/50T15		7314150200450	5	1	T15	50	40
61H/50T20		7314150200467	5	1	T20	50	40
61H/50T25		7314150200474	5	1	T25	50	40
61H/50T30		7314150200481	5	1	T30	50	40
61H/50T40		7314150200498	5	1	T40	50	40

# STAINLESS STEEL **TORSION** SCREWDRIVER BITS

25 PRODUCTS

**INOX SCREWDRIVER BITS  
FOR RUST-FREE  
STAINLESS STEEL**



IDEAL FOR USE ON STAINLESS  
STEEL SCREWS

FITS MOST COMMON SCREW  
HEADS, SUCH AS PHILLIPS,  
POZIDRIV AND TORX®



INOX SCREWDRIVER BITS  
PREVENT RUST FORMATION ON  
STAINLESS STEEL SURFACES

CORE HARDNESS 60-62 HRC

STEEL GREY SURFACE-COATED  
FOR RUST PROTECTION



INNOVATIVE TORSION ZONE  
ABSORBS THE TORQUE PEAKS  
- LESS RISK OF BREAKAGES

## STAINLESS STEEL TORSION SCREWDRIVER BITS - 25 MM



### FEATURES:

- Drive: 1/4" DIN 3126-C6.3, ISO 1173
- Finish: Surface-passivated
- Material: High performance stainless steel, ideal for bits

- Application: Ideal for use on stainless steel screws. Stainless steel bits prevent the formation of rust on the stainless steel surface
- Torsion zone that absorbs torque peaks avoiding premature wear and tear and improving service life

### ASSORTMENT:

#### 651/PH | STAINLESS STEEL TORSION SCREWDRIVER BITS PHILLIPS - 25 MM

Part No.	Barcode	Box	Box	Drive	Length	Weight
651/PH1-2P	7314150207985	2	1	PH1	25	10
651/PH2-2P	7314150201259	2	1	PH2	25	15
651/PH3-2P	7314150201266	2	1	PH3	25	15

Part No.	Barcode	Box	Box	Drive	Length	Weight
651/PH1	7314150199785	10	1	PH1	25	40
651/PH2	7314150199884	10	1	PH2	25	40
651/PH3	7314150199907	10	1	PH3	25	40

#### 651/PZ | STAINLESS STEEL TORSION SCREWDRIVER BITS POZIDRIV - 25 MM

Part No.	Barcode	Box	Box	Drive	Length	Weight
651/PZ1-2P	7314150201273	2	1	PZ1	25	10
651/PZ2-2P	7314150201280	2	1	PZ2	25	15
651/PZ3-2P	7314150201297	2	1	PZ3	25	15

Part No.	Barcode	Box	Box	Drive	Length	Weight
651/PZ1	7314150199921	10	1	PZ1	25	40
651/PZ2	7314150199945	10	1	PZ2	25	40
651/PZ3	7314150199969	10	1	PZ3	25	40

**651/T | STAINLESS STEEL TORSION SCREWDRIVER BITS TORX® - 25 MM**

651/T10-2P	7314150201303	2	1	T10	25	10
651/T15-2P	7314150201310	2	1	T15	25	10
651/T20-2P	7314150201327	2	1	T20	25	15
651/T25-2P	7314150201334	2	1	T25	25	15
651/T30-2P	7314150201341	2	1	T30	25	15
651/T40-2P	7314150201358	2	1	T40	25	15

651/T10	7314150199983	5	1	T10	25	40
651/T15	7314150199990	5	1	T15	25	40
651/T20	7314150200016	5	1	T20	25	40
651/T25	7314150200030	5	1	T25	25	40
651/T30	7314150200054	5	1	T30	25	40
651/T40	7314150200078	5	1	T40	25	40

**651/7**

**STAINLESS STEEL TORSION SCREWDRIVER BIT SET - 7 PCS**



**FEATURES:**

- 7 pcs bit set: 6 stainless steel bits and 1 universal bit holder
- In a hanging cardboard sleeve
- Drive: 1/4" DIN 3126-C6.3, ISO 1173
- Finish: Zinc phosphate

- Material: High-performance alloy steel
- Stainless steel bits prevent the formation of rust on stainless steel surfaces
- With a stainless universal bit holder

**ASSORTMENT:**

651/7-1	7314150204113	7	1	75	65	22 105

**SET CONTAINS:**

651/PH2	
651/PZ2	
651/T15, 651/T20, 651/T25, 651/T30	
1/4"- 50 mm	

# STANDARD SCREWDRIVER BITS

451 PRODUCTS

FOR ALL APPLICATIONS  
IN ENGINEERING, TRADES  
AND INDUSTRY



HIGHLY RESISTANT TO WEAR  
AND TEAR

SCREW HEADS: SLOTTED,  
PHILLIPS, POZIDRIV, TORX®,  
TORX® TAMPER, HEX,  
ROBERTSON®, XZN, TRI-WING  
AND TORQ-SET®



CORE HARDNESS 58-62 HRC

ROBUST SCREWDRIVER BITS FOR  
MANUAL AND MACHINE APPLICATIONS

## STANDARD SCREWDRIVER BITS - 25 MM



### FEATURES:

- Drive: 1/4" DIN 3126-C 6,3, ISO 1173
- Finish: Zinc phosphated

- Material: High performance alloy steel
- Application: Robust and tough bits for universal use

### ASSORTMENT:

#### 59S/ | STANDARD SCREWDRIVER BITS SLOTTED - 25 MM

59S/0.5-3.0-3P	7314150259205	3	1	0,5	3	25	18	
59S/0.5-4.0-3P	7314150259212	3	1	0,5	4	25	18	
59S/0.6-3.5-3P	7314150259229	3	1	0,6	3,5	25	19	
59S/0.6-4.5-3P	7314150201600	3	1	0,6	4,5	25	20	
59S/0.8-5.5-3P	7314150201624	3	1	0,8	5,5	25	20	
59S/1.0-5.5-3P	7314150258963	3	1	1	5,5	25	20	
59S/1.2-6.5-3P	7314150258970	3	1	1,2	6,5	25	21	
59S/1.2-8.0-3P	7314150258987	3	1	1,2	8	25	23	
59S/1.6-9.0-3P	7314150259243	3	1	1,6	9	25	24	
59S/1.6-10-3P	7314150259236	3	1	1,6	10	25	26	

59S/0.5-3.0	7314150199815	10	1	0,5	3	25	40	
59S/0.5-4.0	7314150199822	10	1	0,5	4	25	40	
59S/0.6-3.5	7314150199839	10	1	0,6	3,5	25	40	
59S/0.6-4.5	7314150198801	10	1	0,6	4,5	25	40	
59S/0.8-5.5	7314150198849	10	1	0,8	5,5	25	40	
59S/1.0-5.5	7314150198863	10	1	1	5,5	25	40	
59S/1.2-6.5	7314150198887	10	1	1,2	6,5	25	40	
59S/1.2-8.0	7314150198900	10	1	1,2	8	25	40	
59S/1.6-9.0	7314150199853	10	1	1,6	9	25	40	
59S/1.6-10	7314150199846	10	1	1,6	10	25	40	

**59S/PH | STANDARD SCREWDRIVER BITS PHILLIPS - 25 MM**

59S/PH0-3P	7314150258819	3	1	PH0	25	19	
59S/PH1-3P	7314150201396	3	1	PH1	25	20	
59S/PH2-3P	7314150201402	3	1	PH2	25	20	
59S/PH3-3P	7314150201419	3	1	PH3	25	20	
59S/PH4-3P	7314150258826	3	1	PH4	32	40	
59S/PH0	7314150198177	10	1	PH0	25	40	
59S/PH1	7314150198313	10	1	PH1	25	40	
59S/PH2	7314150198320	10	1	PH2	25	45	
59S/PH3	7314150198351	10	1	PH3	25	50	

59S/PH4	7314150198368	10	1	PH4	32	50	
59S/PH1-30P	7314150200801	30	1	PH1	25	165	
59S/PH2-30P	7314150200818	30	1	PH2	25	180	
59S/PH3-30P	7314150200825	30	1	PH3	25	165	
59S/PH1-IP	7314150206780	100	1	PH1	25	468	
59S/PH2-IP	7314150206797	100	1	PH2	25	468	
59S/PH1-IPB	7314150225743	500	1	PH1	25	2565	
59S/PH2-IPB	7314150204038	500	1	PH2	25	2565	
59S/PH3-IPB	7314150225750	500	1	PH3	25	2565	

**59S/PH2G | STANDARD SCREWDRIVER BITS GRABBER PHILLIPS - 25 MM**

59S/PH2G-3P	7314150259250	3	1	PH2G	25	20	
59S/PH2G	7314150204182	10	1	PH2G	25	50	

59S/PH2G-30P	7314150200832	30	1	PH2G	25	165	

**59S/PZ | STANDARD SCREWDRIVER BITS POZIDRIV - 25 MM**

59S/PZ0-3P	7314150258833	3	1	PZ0	25	18	
59S/PZ1-3P	7314150201426	3	1	PZ1	25	20	
59S/PZ2-3P	7314150201433	3	1	PZ2	25	20	
59S/PZ3-3P	7314150201440	3	1	PZ3	25	20	
59S/PZ0	7314150198375	10	1	PZ0	25	40	
59S/PZ1	7314150198382	10	1	PZ1	25	40	
59S/PZ2	7314150198405	10	1	PZ2	25	50	
59S/PZ3	7314150198429	10	1	PZ3	25	50	
59S/PZ4	7314150198436	10	1	PZ4	32	40	







59S/PZ1-30P	7314150200849	30	1	PZ1	25	165	
59S/PZ2-30P	7314150200856	30	1	PZ2	25	180	
59S/PZ3-30P	7314150200863	30	1	PZ3	25	165	
59S/PZ1-IP	7314150206803	100	1	PZ1	25	468	
59S/PZ2-IP	7314150206810	100	1	PZ2	25	468	
59S/PZ1-IPB	7314150204373	500	1	PZ1	25	2565	
59S/PZ2-IPB	7314150204380	500	1	PZ2	25	2565	
59S/PZ3-IPB	7314150225736	500	1	PZ3	25	2565	





**59S/T | STANDARD SCREWDRIVER BITS TORX® - 25 MM**

59S/T3-3P	7314150258840	3	1	T3	25	18	
59S/T4-3P	7314150258857	3	1	T4	25	18	
59S/T5-3P	7314150258864	3	1	T5	25	18	
59S/T6-3P	7314150258871	3	1	T6	25	18	
59S/T7-3P	7314150258888	3	1	T7	25	18	
59S/T8-3P	7314150258895	3	1	T8	25	18	
59S/T9-3P	7314150258901	3	1	T9	25	19	
59S/T10-3P	7314150201457	3	1	T10	25	20	
59S/T15-3P	7314150201464	3	1	T15	25	20	
59S/T20-3P	7314150201471	3	1	T20	25	20	
59S/T25-3P	7314150201488	3	1	T25	25	20	
59S/T27-3P	7314150201495	3	1	T27	25	20	
59S/T30-3P	7314150201501	3	1	T30	25	20	
59S/T40-3P	7314150201518	3	1	T40	25	20	
59S/T45-3P	7314150258918	3	1	T45	25	27	
59S/T50-3P	7314150258925	3	1	T50	25	27	
59S/T3	7314150198443	5	1	T3	25	35	
59S/T4	7314150198450	5	1	T4	25	35	
59S/T5	7314150198467	5	1	T5	25	35	







59S/T6	7314150198474	10	1	T6	25	40	
59S/T7	7314150198498	10	1	T7	25	40	
59S/T8	7314150198504	10	1	T8	25	40	
59S/T9	7314150198511	10	1	T9	25	40	
59S/T10	7314150198528	10	1	T10	25	40	
59S/T15	7314150198535	10	1	T15	25	40	
59S/T20	7314150198542	10	1	T20	25	40	
59S/T25	7314150198566	10	1	T25	25	40	
59S/T27	7314150198580	10	1	T27	25	40	
59S/T30	7314150198597	5	1	T30	25	45	
59S/T40	7314150198610	5	1	T40	25	45	
59S/T45	7314150198641	5	1	T45	25	50	
59S/T50	7314150198658	5	1	T50	25	50	
59S/T10-30P	7314150200870	30	1	T10	25	165	
59S/T15-30P	7314150200887	30	1	T15	25	165	
59S/T20-30P	7314150200894	30	1	T20	25	180	
59S/T25-30P	7314150200900	30	1	T25	25	165	
59S/T30-30P	7314150200924	30	1	T30	25	165	
59S/T40-30P	7314150200931	30	1	T40	25	165	







## **59S/TR** | STANDARD SCREWDRIVER BITS TORX® TAMPER - 25 MM

						
59S/TR7-3P	7314150258932	3	1	TR7	25	18
59S/TR8-3P	7314150258949	3	1	TR8	25	18
59S/TR9-3P	7314150258956	3	1	TR9	25	19
59S/TR10-3P	7314150201525	3	1	TR10	25	20
59S/TR15-3P	7314150201532	3	1	TR15	25	20
59S/TR20-3P	7314150201549	3	1	TR20	25	20
59S/TR25-3P	7314150201556	3	1	TR25	25	20
59S/TR27-3P	7314150201570	3	1	TR27	25	20
59S/TR30-3P	7314150201587	3	1	TR30	25	20
59S/TR40-3P	7314150201594	3	1	TR40	25	20







						
59S/TR7	7314150198672	5	1	TR7	25	20
59S/TR8	7314150198689	5	1	TR8	25	20
59S/TR9	7314150198696	5	1	TR9	25	20
59S/TR10	7314150198702	5	1	TR10	25	20
59S/TR15	7314150198719	5	1	TR15	25	25
59S/TR20	7314150198726	5	1	TR20	25	25
59S/TR25	7314150198740	5	1	TR25	25	25
59S/TR27	7314150198757	5	1	TR27	25	25
59S/TR30	7314150198771	5	1	TR30	25	25
59S/TR40	7314150198795	5	1	TR40	25	25







## **59S/H MM** | STANDARD SCREWDRIVER BITS HEX METRIC - 25 MM

						
59S/H1.5-3P	7314150258994	3	1	1,5	25	20
59S/H2-3P	7314150259007	3	1	2	25	20
59S/H2.5-3P	7314150259014	3	1	2,5	25	20
59S/H3-3P	7314150201662	3	1	3	25	20
59S/H4-3P	7314150201679	3	1	4	25	20
59S/H5-3P	7314150201686	3	1	5	25	20
59S/H6-3P	7314150201693	3	1	6	25	20
59S/H8-3P	7314150201709	3	1	8	25	30
59S/H10-3P	7311518333638	3	1	10	25	35
59S/H1.5	7314150198924	5	1	1,5	25	19







						
59S/H2	7314150198955	5	1	2	25	19
59S/H2.5	7314150198962	5	1	2,5	25	19
59S/H3	7314150198986	5	1	3	25	20
59S/H4	7314150198993	5	1	4	25	20
59S/H5	7314150199013	5	1	5	25	20
59S/H6	7314150199037	5	1	6	25	25
59S/H8	7314150199051	5	1	8	25	30
59S/H10	7314150199075	5	1	10	25	40
59S/H4-IPB	7314150225767	500	1	4	25	2565







## **59S/H"** | STANDARD SCREWDRIVER BITS HEX IMPERIAL - 25 MM

						
59S/H1/16-3P	7314150259021	3	1	1/16	25	18
59S/H5/64-3P	7314150259038	3	1	5/64	25	19
59S/H3/32-3P	7314150259045	3	1	3/32	25	19
59S/H7/64-3P	7314150259052	3	1	7/64	25	19
59S/H1/8-3P	7314150259069	3	1	1/8	25	20
59S/H9/64-3P	7314150259076	3	1	9/64	25	20
59S/H5/32-3P	7314150259083	3	1	5/32	25	21
59S/H3/16-3P	7314150259090	3	1	3/16	25	22
59S/H7/32-3P	7314150259113	3	1	7/32	25	24
59S/H1/4-3P	7314150259120	3	1	1/4	25	25
59S/H5/16-3P	7314150259137	3	1	5/16	25	31
59S/H3/8-3P	7314150259144	3	1	3/8	25	40







						
59S/H1/16	7314150204205	5	1	1/16	25	20
59S/H5/64	7314150199112	5	1	5/64	25	20
59S/H3/32	7314150199136	5	1	3/32	25	20
59S/H7/64	7314150199150	5	1	7/64	25	25
59S/H1/8	7314150199174	5	1	1/8	25	25
59S/H9/64	7314150199198	5	1	9/64	25	25
59S/H5/32	7314150199204	5	1	5/32	25	30
59S/H3/16	7314150199228	5	1	3/16	25	30
59S/H7/32	7314150199242	5	1	7/32	25	30
59S/H1/4	7314150199266	5	1	1/4	25	40
59S/H5/16	7314150199273	5	1	5/16	25	40
59S/H3/8	7314150204212	5	1	3/8	25	40







## **59S/R** | STANDARD SCREWDRIVER BITS ROBERTSON® - 25 MM

						
59S/R1-3P	7314150201631	3	1	#1	25	20
59S/R2-3P	7314150201648	3	1	#2	25	20
59S/R3-3P	7314150201655	3	1	#3	25	20
59S/R1	7314150199310	10	1	#1	25	40

						
59S/R2	7314150199341	10	1	#2	25	40
59S/R3	7314150199365	10	1	#3	25	40
59S/R4	7314150232109	10	1	#4	25	40

## **59S/TS** | STANDARD SCREWDRIVER BITS TORQ-SET® METRIC - 25 MM

						
59S/TS-0	7314150199389	5	1	0	25	40
59S/TS-1	7314150199396	5	1	1	25	40
59S/TS-2	7314150199419	5	1	2	25	40
59S/TS-3	7314150199433	5	1	3	25	40
59S/TS-4	7314150199457	5	1	4	25	40

						
59S/TS-5	7314150199518	5	1	5	25	40
59S/TS-6	7314150199532	5	1	6	25	40
59S/TS-8	7314150199556	5	1	8	25	40
59S/TS-10	7314150199570	5	1	10	25	40

**+ 59S/TS<sup>®</sup> | STANDARD SCREWDRIVER BITS TORQ-SET<sup>®</sup> IMPERIAL - 25 MM**

59S/TS-1/4	7314150199594	5	1	1/4	25	40	

**▲ 59S/TW | STANDARD SCREWDRIVER BITS TRI-WING - 25 MM**

59S/TW0	7314150199617	5	1	TW 0	25	40	
59S/TW1	7314150199631	5	1	TW 1	25	40	
59S/TW2	7314150199655	5	1	TW 2	25	40	

59S/TW3	7314150199679	5	1	TW 3	25	40	
59S/TW4	7314150199693	5	1	TW 4	25	40	
59S/TW5	7314150199716	5	1	TW 5	25	40	

**● 59S/M | STANDARD SCREWDRIVER BITS XZN - 25 MM**

59S/M3-3P	7314150259151	3	1	M3	25	19	
59S/M4-3P	7314150259168	3	1	M4	25	20	
59S/M5-3P	7314150259175	3	1	M5	25	20	
59S/M6-3P	7314150259182	3	1	M6	25	24	
59S/M8-3P	7314150259199	3	1	M8	25	27	

59S/M3	7314150199730	10	1	M3	25	40	
59S/M4	7314150199754	10	1	M4	25	40	
59S/M5	7314150199778	10	1	M5	25	40	
59S/M6	7314150199792	10	1	M6	25	40	
59S/M8	7314150199808	10	1	M8	25	40	

## STANDARD SCREWDRIVER BITS - 50 MM



**ASSORTMENT:**

**— 59S/50 | STANDARD SCREWDRIVER BITS SLOTTED - 50 MM**

59S/50/3.5-2P	7314150260027	2	1	0,6	3,5	50	23	
59S/50/4.0-2P	7314150260041	2	1	0,8	4	50	23	
59S/50/5.5-2P	7314150260065	2	1	0,8	5,5	50	27	
59S/50/6.0-2P	7314150260089	2	1	1	6	50	28	
59S/50/6.5-2P	7314150260102	2	1	1,2	6,5	50	30	

59S/50/0.6-3.5	7314150199976	5	1	0,6	3,5	50	30	
59S/50/0.8-4.0	7314150200009	5	1	0,8	4	50	30	
59S/50/0.8-5.5	7314150200023	5	1	0,8	5,5	50	30	
59S/50/1.0-6.0	7314150200047	5	1	1	6	50	36,5	
59S/50/1.2-6.5	7314150200061	5	1	1,2	6,5	50	36,5	

**+ 59S/50PH | STANDARD SCREWDRIVER BITS PHILLIPS - 50 MM**

59S/50PH1-2P	7314150203642	2	1	PH1	50	25	
59S/50PH2-2P	7314150203758	2	1	PH2	50	30	
59S/50PH3-2P	7314150203802	2	1	PH3	50	30	

59S/50PH1	7314150199860	5	1	PH1	50	70	
59S/50PH2	7314150199877	5	1	PH2	50	70	
59S/50PH3	7314150199891	5	1	PH3	50	70	

**+ 59S/50PZ | STANDARD SCREWDRIVER BITS POZIDRIV - 50 MM**

59S/50PZ1-2P	7314150204007	2	1	PZ1	50	25	
59S/50PZ2-2P	7314150204014	2	1	PZ2	50	30	
59S/50PZ3-2P	7314150204021	2	1	PZ3	50	30	

59S/50PZ1	7314150199914	5	1	PZ1	50	70	
59S/50PZ2	7314150199938	5	1	PZ2	50	70	
59S/50PZ3	7314150199952	5	1	PZ3	50	70	

**59S/50T | STANDARD SCREWDRIVER BITS TORX® - 50 MM**

59S/50T8-2P	7314150262809	2	1	T8	50	22
59S/50T10-2P	7314150201723	2	1	T10	50	25
59S/50T15-2P	7314150201730	2	1	T15	50	25
59S/50T20-2P	7314150201747	2	1	T20	50	25
59S/50T25-2P	7314150201754	2	1	T25	50	25
59S/50T30-2P	7314150201761	2	1	T30	50	30
59S/50T40-2P	7314150259281	2	1	T40	50	32
59S/50T8	7314150200085	5	1	T8	50	40

59S/50T10	7314150200092	5	1	T10	50	40
59S/50T15	7314150200108	5	1	T15	50	40
59S/50T20	7314150200115	5	1	T20	50	40
59S/50T25	7314150200122	5	1	T25	50	50
59S/50T27	7314150200139	5	1	T27	50	50
59S/50T30	7314150200146	5	1	T30	50	50
59S/50T40	7314150200153	5	1	T40	50	50

**59S/50H | STANDARD SCREWDRIVER BITS HEX METRIC - 50 MM**

59S/50H2-2P	7314150259298	2	1	2	50	22
59S/50H2.5-2P	7314150259304	2	1	2,5	50	22
59S/50H3-2P	7314150259335	2	1	3	50	24
59S/50H4-2P	7314150259359	2	1	4	50	26
59S/50H5-2P	7314150259373	2	1	5	50	29
59S/50H6-2P	7314150259397	2	1	6	50	32
59S/50H8-2P	7314150259410	2	1	8	50	40

59S/50H2	7314150200160	5	1	2	50	40
59S/50H2.5	7314150200177	5	1	2,5	50	40
59S/50H3	7314150200184	5	1	3	50	40
59S/50H4	7314150200191	5	1	4	50	40
59S/50H5	7314150200207	5	1	5	50	40
59S/50H6	7314150200214	5	1	6	50	40
59S/50H8	7314150200221	5	1	8	50	50

**59S/50H" | STANDARD SCREWDRIVER BITS HEX IMPERIAL - 50 MM**

59S/50H1/16	7314150248926	5	1	1/16	50	75
59S/50H5/64	7314150249015	5	1	5/64	50	75
59S/50H3/32	7314150248964	5	1	3/32	50	76
59S/50H7/64	7314150248995	5	1	7/64	50	76
59S/50H1/8	7314150248940	5	1	1/8	50	77
59S/50H9/64	7314150249039	5	1	9/64	50	77

59S/50H5/32	7314150249022	5	1	5/32	50	78
59S/50H3/16	7314150248988	5	1	3/16	50	78
59S/50H7/32	7314150248933	5	1	7/32	50	79
59S/50H1/4	7314150249008	5	1	1/4	50	79
59S/50H5/16	7314150248957	5	1	5/16	50	80
59S/50H3/8	7314150248971	5	1	3/8	50	80

**59S/50R | STANDARD SCREWDRIVER BITS ROBERTSON® - 50 MM**

59S/50R1-2P	7314150259441	2	1	#1	50	24
59S/50R2-2P	7314150259472	2	1	#2	50	26
59S/50R3-2P	7314150259502	2	1	#3	50	28

59S/50R1	7314150200238	5	1	#1	50	40
59S/50R2	7314150200245	5	1	#2	50	40
59S/50R3	7314150200252	5	1	#3	50	40



# STANDARD SCREWDRIVER BITS - 70 MM



## ASSORTMENT:

### PHILLIPS | STANDARD SCREWDRIVER BITS PHILLIPS - 70 MM

59S/70PH1-2P		7314150259526	2	1	PH1	70	31
59S/70PH2-2P		7314150259557	2	1	PH2	70	38

59S/70PH1		7314150200269	5	1	PH1	70	70
59S/70PH2		7314150200276	5	1	PH2	70	70

### POZIDRIV | STANDARD SCREWDRIVER BITS POZIDRIV - 70 MM

59S/70PZ1-2P		7314150259564	2	1	PZ1	70	32
59S/70PZ2-2P		7314150260331	2	1	PZ2	70	38
59S/70PZ3-2P		7314150260348	2	1	PZ3	70	38

59S/70PZ1		7314150200283	5	1	PZ1	70	70
59S/70PZ2		7314150200290	5	1	PZ2	70	70
59S/70PZ3		7314150200306	5	1	PZ3	70	80

### TORX® | STANDARD SCREWDRIVER BITS TORX® - 70 MM

59S/70T10-2P		7314150260355	2	1	T10	70	28
59S/70T15-2P		7314150260362	2	1	T15	70	30
59S/70T20-2P		7314150201839	2	1	T20	70	25
59S/70T25-2P		7314150260379	2	1	T25	70	32
59S/70T27-2P		7314150260386	2	1	T27	70	38
59S/70T30-2P		7314150260393	2	1	T30	70	38
59S/70T40-2P		7314150260409	2	1	T40	70	44

59S/70T10		7314150200313	5	1	T10	70	70
59S/70T15		7314150200566	5	1	T15	70	70
59S/70T20		7314150200573	5	1	T20	70	70
59S/70T25		7314150200580	5	1	T25	70	80
59S/70T27		7314150200597	5	1	T27	70	80
59S/70T30		7314150200603	5	1	T30	70	80
59S/70T40		7314150200610	5	1	T40	70	80

### TORX® TAMPER | STANDARD SCREWDRIVER BITS TORX® TAMPER - 70 MM

59S/70TR15-2P		7314150260416	2	1	TR15	70	28
59S/70TR20-2P		7314150260423	2	1	TR20	70	32
59S/70TR25-2P		7314150260430	2	1	TR25	70	34
59S/70TR27-2P		7314150260447	2	1	TR27	70	38
59S/70TR30-2P		7314150260454	2	1	TR30	70	40
59S/70TR40-2P		7314150260461	2	1	TR40	70	44

59S/70TR15		7314150200627	5	1	TR15	70	70
59S/70TR20		7314150200634	5	1	TR20	70	70
59S/70TR25		7314150200641	5	1	TR25	70	80
59S/70TR27		7314150200658	5	1	TR27	70	80
59S/70TR30		7314150200665	5	1	TR30	70	80
59S/70TR40		7314150200672	5	1	TR40	70	80

## STANDARD SCREWDRIVER BITS - 89 MM

















### FEATURES:

- Drive: 1/4" DIN 3126-E 6,3, ISO 1173
- Finish: Zinc phosphated
- Material: High-performance alloy steel
- Application: For all screw applications in trade and industry
- Hex ball point bits facilitate working in confined spaces by allowing use at an angle

### ASSORTMENT:

#### **59S/H BALL** STANDARD SCREWDRIVER BITS HEX BALL POINT METRIC - 89 MM

							
59S/H3BALL-2P	7314150260478	2	1	3	89	52	
59S/H4BALL-2P	7314150260485	2	1	4	89	52	
59S/H5BALL-2P	7314150260492	2	1	5	89	52	
59S/H6BALL-2P	7314150260508	2	1	6	89	55	
59S/H8BALL-2P	7314150260515	2	1	8	89	72	
59S/HBALL-3P	7314150201716	3	1	5, 6, 8	89	84	

							
59S/H3BALL	7314150200689	5	1	3	89	90	
59S/H4BALL	7314150200696	5	1	4	89	90	
59S/H5BALL	7314150200702	5	1	5	89	90	
59S/H6BALL	7314150200719	5	1	6	89	90	
59S/H8BALL	7314150200726	5	1	8	89	90	

## STANDARD SCREWDRIVER BITS - 125 MM

















### FEATURES:

- Drive: 1/4" DIN 3126-E 6,3, ISO 1173
- Finish: Zinc phosphated
- Material: High-performance alloy steel
- Application: For all screw applications in trade and industry







### ASSORTMENT:







#### **59S/125PH** STANDARD SCREWDRIVER BITS PHILLIPS - 125 MM

							
59S/125PH1-2P	7314150260553	2	1	PH1	125	48	
59S/125PH2-2P	7314150260560	2	1	PH2	125	64	
59S/125PH3-2P	7314150260577	2	1	PH3	125	64	







							
59S/125PH1	7314150206834	5	1	PH1	125	100	
59S/125PH2	7314150204298	5	1	PH2	125	100	
59S/125PH3	7314150204304	5	1	PH3	125	100	







#### **59S/125PZ** STANDARD SCREWDRIVER BITS POZIDRIV - 125 MM

							
59S/125PZ1-2P	7314150260522	2	1	PZ1	125	48	
59S/125PZ2-2P	7314150260539	2	1	PZ2	125	66	
59S/125PZ3-2P	7314150260546	2	1	PZ3	125	66	

							
59S/125PZ1	7314150200733	5	1	PZ1	125	100	
59S/125PZ2	7314150200740	5	1	PZ2	125	100	
59S/125PZ3	7314150200757	5	1	PZ3	125	100	

#### **59S/PH COMBI** STANDARD SCREWDRIVER BITS PHILLIPS/SLOTTED COMBI - 125 MM

							
59S/PH1COMBI-2P	7314150215669	2	1	5	PH1	125	60
59S/PH2COMBI-2P	7314150203604	2	1	6	PH2	125	60

							
59S/PH3COMBI-2P	7314150203611	2	1	8	PH3	125	60

## STANDARD SCREWDRIVER BITS - 150 MM



### FEATURES:

- Drive: 1/4" DIN 3126-E 6,3, ISO 1173
- Finish: Zinc phosphated
- Material: High-performance alloy steel
- Application: For all screw applications in trade and industry
- Hex ball point bits facilitate working in confined spaces by allowing use at an angle

### ASSORTMENT:

#### ★ 59S/150T | STANDARD SCREWDRIVER BITS TORX® - 150 MM

Icon	Barcode	Icon X	Icon	Icon	Icon	Icon	Icon
59S/150T15-2P	7314150260584	2	1	T15	150	48	
59S/150T20-2P	7314150260591	2	1	T20	150	58	
59S/150T25-2P	7314150260607	2	1	T25	150	60	
59S/150T30-2P	7314150260614	2	1	T30	150	78	

Icon	Barcode	Icon X	Icon	Icon	Icon	Icon	Icon
59S/150T15	7314150200764	5	1	T15	150	150	
59S/150T20	7314150200771	5	1	T20	150	150	
59S/150T25	7314150200788	5	1	T25	150	150	
59S/150T30	7314150200795	5	1	T30	150	150	

## STANDARD SCREWDRIVER BITS 5/16" - 30 TO 41 MM



### FEATURES:

- Drive: 5/16" DIN 3126-C 8, ISO 1173
- Finish: Zinc phosphated
- Material: High performance alloy steel

### ASSORTMENT:

#### — 70S | STANDARD SCREWDRIVER BITS 5/16" SLOTTED - 41 MM

Icon	Barcode	Icon X	Icon	Icon	Icon	Icon	Icon	Icon
70S/1.2-8.0-2P	7314150262823	2	1	1,2	8	41	38	
70S/1.6-9.0-2P	7314150261024	2	1	1,6	9	41	38	
70S/1.6-10.0-2P	7314150261017	2	1	1,6	10	41	44	
70S/2.0-12.0-2P	7314150261086	2	1	2	12	41	52	
70S/2.5-14.0-2P	7314150261147	2	1	2,5	14	41	60	

Icon	Barcode	Icon X	Icon	Icon	Icon	Icon	Icon	Icon
70S/1.2-8.0	7314150218387	5	1	1,2	8	41	100	
70S/1.6-9.0	7314150218400	5	1	1,6	9	41	105	
70S/1.6-10.0	7314150218394	5	1	1,6	10	41	110	
70S/2.0-12.0	7314150218417	5	1	2	12	41	120	
70S/2.5-14.0	7314150218424	5	1	2,5	14	41	140	

#### ★ 70S/PH | STANDARD SCREWDRIVER BITS 5/16" PHILLIPS - 32 TO 38 MM

Icon	Barcode	Icon X	Icon	Icon	Icon	Icon	Icon
70S/PH1-2P	7314150260621	2	1	PH1	32	30	
70S/PH2-2P	7314150260638	2	1	PH2	32	30	
70S/PH3-2P	7314150260645	2	1	PH3	32	30	
70S/PH4-2P	7314150260652	2	1	PH4	38	36	

Icon	Barcode	Icon X	Icon	Icon	Icon	Icon	Icon
70S/PH1	7314150217557	5	1	PH1	32	75	
70S/PH2	7314150217564	5	1	PH2	32	75	
70S/PH3	7314150217571	5	1	PH3	32	75	
70S/PH4	7314150217588	5	1	PH4	38	85	

#### ★ 70S/PZ | STANDARD SCREWDRIVER BITS 5/16" POZIDRIV - 32 TO 38 MM

Icon	Barcode	Icon X	Icon	Icon	Icon	Icon	Icon
70S/PZ1-2P	7314150260683	2	1	PZ1	32	30	
70S/PZ2-2P	7314150260706	2	1	PZ2	32	30	
70S/PZ3-2P	7314150260720	2	1	PZ3	32	30	
70S/PZ4-2P	7314150260737	2	1	PZ4	38	36	

Icon	Barcode	Icon X	Icon	Icon	Icon	Icon	Icon
70S/PZ1	7314150217595	5	1	PZ1	32	75	
70S/PZ2	7314150217601	5	1	PZ2	32	75	
70S/PZ3	7314150217724	5	1	PZ3	32	75	
70S/PZ4	7314150217731	5	1	PZ4	38	85	

## ★ 70S/T | STANDARD SCREWDRIVER BITS 5/16" TORX® - 35 MM

70S/T20-2P	7314150260744	2	1	T20	35	30
70S/T25-2P	7314150260812	2	1	T25	35	30
70S/T27-2P	7314150260867	2	1	T27	35	31
70S/T30-2P	7314150260881	2	1	T30	35	32
70S/T40-2P	7314150260898	2	1	T40	35	32
70S/T45-2P	7314150260904	2	1	T45	35	34
70S/T50-2P	7314150260911	2	1	T50	35	36
70S/T55-2P	7314150260928	2	1	T55	35	44

70S/T20	7314150217748	5	1	T20	35	65
70S/T25	7314150217755	5	1	T25	35	65
70S/T27	7314150217762	5	1	T27	35	65
70S/T30	7314150217779	5	1	T30	35	65
70S/T40	7314150217786	5	1	T40	35	65
70S/T45	7314150217793	5	1	T45	35	80
70S/T50	7314150217809	5	1	T50	35	80
70S/T55	7314150217816	5	1	T55	35	105

## ● 70S/H | STANDARD SCREWDRIVER BITS 5/16" HEX METRIC - 30 MM

70S/H4-2P	7314150261352	2	1	4	30	26
70S/H5-2P	7314150261406	2	1	5	30	28
70S/H6-2P	7314150261437	2	1	6	30	30
70S/H7-2P	7314150261444	2	1	7	30	30
70S/H8-2P	7314150262847	2	1	8	30	32
70S/H10-2P	7314150261451	2	1	10	30	40
70S/H12-2P	7314150261468	2	1	12	30	46
70S/H14-2P	7314150261475	2	1	14	30	54

70S/H4	7314150218431	5	1	4	30	60
70S/H5	7314150218448	5	1	5	30	65
70S/H6	7314150218455	5	1	6	30	65
70S/H7	7314150218462	5	1	7	30	75
70S/H8	7314150218479	5	1	8	30	80
70S/H10	7314150218486	5	1	10	30	95
70S/H12	7314150218493	5	1	12	30	115
70S/H14	7314150218509	5	1	14	30	140

## + 70S/TS | STANDARD SCREWDRIVER BITS 5/16" TORQ-SET® METRIC & IMPERIAL - 32 MM

70S/TS8-2P	7314150260966	2	1	8	32	30
70S/TS10-2P	7314150260942	2	1	10	32	30
70S/TS1/4-2P	7314150260935	2	1	1/4	32	32
70S/TS5/16-2P	7314150260959	2	1	5/16	32	30

70S/TS8	7314150218370	5	1	8	32	70
70S/TS10	7314150218356	5	1	10	32	75
70S/TS1/4	7314150218349	5	1	1/4	32	75
70S/TS5/16	7314150218363	5	1	5/16	32	70

## STANDARD SCREWDRIVER BITS 5/32"



### FEATURES:

- Drive: 5/32" DIN 3126-C 4, ISO 1173
- Material: High performance alloy steel
- Finish: Zinc phosphated

### ASSORTMENT:

## + 45S/PH | STANDARD SCREWDRIVER BITS PHILLIPS 5/32" - 25 MM

45S/PH1-2P	7314150261482	2	1	PH1	25	10
45S/PH2-2P	7314150261499	2	1	PH2	25	11

45S/PH1	7314150218516	5	1	PH1	25	25
45S/PH2	7314150218523	5	1	PH2	25	25

## ● 45S/H | STANDARD SCREWDRIVER BITS HEX 5/32" - 20 MM

45S/H1.5-2P	7314150261505	2	1	1.5	20	9
45S/H2-2P	7314150261512	2	1	2	20	9
45S/H2.5-2P	7314150261529	2	1	2.5	20	9
45S/H3-2P	7314150261536	2	1	3	20	9

45S/H1.5	7314150218530	5	1	1.5	20	20
45S/H2	7314150218547	5	1	2	20	25
45S/H2.5	7314150218554	5	1	2.5	20	25
45S/H3	7314150218561	5	1	3	20	20

## STANDARD SCREWDRIVER BITS 7/16" - 35 MM



### FEATURES:

- Drive: 11.2 mm (7/16") DIN 3126-E11,2, ISO 1173
- Finish: Zinc phosphated
- Material: High-performance alloy steel
- Bit holding: Locking screw
- Suitable adaptors, 7809H

### ASSORTMENT:

#### 74S/H | STANDARD SCREWDRIVER BITS HEX - 35 MM

74S/H4-2P	7314150261543	2	1	4	35	48
74S/H5-2P	7314150261550	2	1	5	35	50
74S/H6-2P	7314150261567	2	1	6	35	52
74S/H7-2P	7314150261574	2	1	7	35	54
74S/H8-2P	7314150261611	2	1	8	35	56
74S/H10-2P	7314150261635	2	1	10	35	64
74S/H12-2P	7314150261659	2	1	12	35	72
74S/H14-2P	7314150261666	2	1	14	35	80
74S/H17-2P	7314150261673	2	1	17	35	96

74S/H4	7314150218578	5	1	4	35	115
74S/H5	7314150218585	5	1	5	35	120
74S/H6	7314150218592	5	1	6	35	125
74S/H7	7314150218608	5	1	7	35	125
74S/H8	7314150218615	5	1	8	35	130
74S/H10	7314150218622	5	1	10	35	150
74S/H12	7314150218639	5	1	12	35	190
74S/H14	7314150218646	5	1	14	35	190
74S/H17	7314150218653	5	1	17	35	240

## STANDARD SCREWDRIVER BITS THREAD DRIVE - 44,5 MM



### FEATURES:

- Screwdriver Bits with tread drive optimised for use in stationary machines
- DUOFAST automatic screwdriver, for BOSCH, FEIN and MAKITA screwdrivers or HOLZ-HER magazine screwdrivers
- Steel-grey, greased finish
- High-performance alloy steel
- Length: 44.5mm
- Packed individually in a plastic bag

### PHILLIPS:

- K18NF-2: Screw thread 10/32" UNF
- K18PH-2M5: Screw thread M5
- K18PH-2M6: Screw thread M6

### POZIDRIV:

- K19PZD-2NF: Screw thread 10/32" UNF
- K19PZD-2M5: Screw thread M5

### TORX®:

- Screw thread 10/32" UNF

### ASSORTMENT:

#### K18 | STANDARD SCREWDRIVER BITS THREAD DRIVE PHILLIPS - 44,5 MM

K18NF-2	7314151347161	1	5	PH2	44,5	12
K18PH-2M5	7314153019646	1	5	PH2	45,5	12
K18PH-2M6	7314150274871	1	5	PH2	45,5	12

#### K19PZD-2NF | STANDARD SCREWDRIVER BITS THREAD DRIVE POZIDRIV - 44,5 MM

K19PZD-2NF	7314151586157	1	10	P22	44,5	12
K19PZD-2M5	7314151693237	1	10	P22	44,5	12

#### K20TORX | STANDARD SCREWDRIVER BITS THREAD DRIVE TORX® - 44,5 MM

K20TORX-T25	7314151825799	1	10	T25	44,5	10

59S/7

## STANDARD SCREWDRIVER BIT SET AND BIT HOLDER - 7 PCS



### FEATURES:

- 7 pcs bit set: 6 bits and 1 universal bit holder
- In a hanging cardboard sleeve
- Drive: 1/4" DIN 3126-C6.3, ISO 1173

### ASSORTMENT:

59S/7-1	7314150191536	7	1	75	65	22	105

59S/7-2	7314150191543	7	1	75	65	22	105

59S/7-3	7314150191550	7	1	75	65	22	105

59S/7-4	7314150191567	7	1	75	65	22	105

- Finish: Zinc phosphate
- Material: High-performance alloy steel

### SET CONTAINS:

59S/PH1, PH2		
59S/PZ1, PZ2		
59S/T15, T20		
1/4" - 50 mm		

59S/PH2		
59S/T15, 2xT20, 2xT25		
1/4" - 50 mm		

59S/TR10, TR15, TR20, TR25, TR30, TR40		
1/4" - 50 mm		

59S/T10, T15, T20, T25, T30, T40		
1/4" - 50 mm		

59S/17

## STANDARD SCREWDRIVER BIT SET AND BIT HOLDER - 17 PCS



### FEATURES:

- 17 pcs bit set: 16 bits and 1 magnetic quick-release bit holder
- In cardboard packaging

### ASSORTMENT:

59S/17-1	7314150191499	17	1	82	73	27	130

59S/17-2	7314150191505	17	1	82	73	27	130

59S/17-3	7314150191512	17	1	82	73	27	130

- Drive: 1/4" DIN 3126-C6.3, ISO 1173
- Finish: Zinc phosphate
- Material: High-performance alloy steel

### SET CONTAINS:

59S/3.0, 4.5, 5.5 mm	
59S/PH1, 3xPH2, 2xPH2G	
59S/PZ1, 2xPZ2	
59S/H3.0, 4.0, 5.0, 6.0 mm	
1/4" - 50 mm	

59S/T7, T8, T9, T10, 2xT15, 3xT20, 3xT25, T27, 2xT30, T40	
1/4" - 50 mm	

59S/PH1, 2xPH2	
59S/PZ1, PZ2, PZ3	
59S/T10, T15, T20, T25, T27, T30, T40	
59S/H3.0, 4.0, 5.0 mm	
1/4" - 50 mm	

59S/22

## STANDARD SCREWDRIVER BIT SET, BIT HOLDER AND 1/4" SOCKET ADAPTOR - 22 PCS

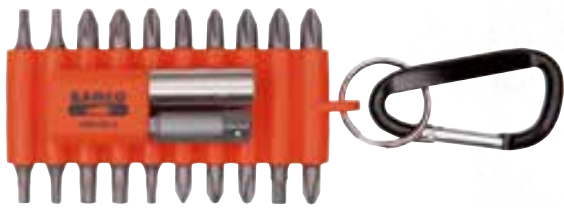

### FEATURES:

- 22 pcs rubber holder: 20 bits, 1 universal magnetic bit holder and 1 socket adaptor 1/4"
- In a hanging cardboard sleeve

- Drive: 1/4" DIN 3126-C6.3,ISO 1173
- Finish: Zinc phosphate
- Material: High-performance alloy steel

### ASSORTMENT:

59S/22-1	7314150204229	22	1	80	50	20	155

59S/22-2	7314150204236	22	1	80	50	20	155

### SET CONTAINS:

59S/3.0, 4.5, 5.5 mm		
59S/PH1, PH2, PH3, PH2G		
59S/PZ1, PZ2, PZ3		
59S/T6, T8, T9, T10, T15, T20, T25, T27, T30, T40		
1/4" - 50 mm		
K6650-1/4" - 50 mm		

59S/2.5, 3.0 mm		
3x59S/PH2, 3xPH2G		
2x59S/PZ2		
59S/T10, 4xT15, 3xT20, 2xT25		
1/4" - 50 mm		
K6650-1/4" - 50 mm		



59/S28

## STANDARD SCREWDRIVER BIT SET, BIT HOLDER AND 1/4" SOCKET ADAPTOR - 28 PCS



### FEATURES:

- 28 pcs set: 26 bits + 1 adaptor + 1 universal holder
- Small box with rounded corners that can be easily stored in a pocket

### ASSORTMENT:

59/S28-4	7314151847173	28	1	30	110	55	155	

### SET CONTAINS:

59S/0.6x4.5, 1.2x6.5, 1.2x8.0 mm		
2x59S/PH1, 2xPH2, PH3		
59S/T6, T15		
59S/H1/8, 3/16, 3/32, 5/32, 5/64, 7/32, 7/64, 9/64		
2x59S/TS-4, 2xTS-6, 2xTS-8, 2xTS-10		
K6625-1/4		
KM653		

59/S31B

## STANDARD SCREWDRIVER BIT SET, BIT HOLDER AND 1/4" SOCKET ADAPTOR - 31 PCS



### FEATURES:

- 31 pcs bit set for slotted, Phillips, Pozidriv, TORX®, Hexagon head screws, bit holder and socket adaptor 1/4"
- In cardboard packaging
- Drive: 1/4" DIN 3126-C6.3, ISO 1173

- Finish: Sand blasting
- Material: S2 high-alloy steel
- 59/S31B-IP: in bulk. Served in a counter display of 12 pcs

### ASSORTMENT:

59/S31B	7314150325788	31	1	65,35	104,9	40,25	244

### SET CONTAINS:

	Slotted	4.5	25mm	1
	Slotted	5.5	25mm	1
	Phillips	PH1	25mm	1
	Phillips	PH2	25mm	3
	Phillips	PH3	25mm	1
	Grabber Phillips	PH2G	25mm	2
	Pozidriv	PZ1	25mm	1
	Pozidriv	PZ2	25mm	3
	Pozidriv	PZ3	25mm	1
	TORX	T10	25mm	1
	TORX	T15	25mm	3
	TORX	T20	25mm	3
	TORX	T25	25mm	2
	TORX	T27	25mm	1
	TORX	T30	25mm	1
	Hexagonal	HEX3	25mm	1
	Hexagonal	HEX4	25mm	1
	Hexagonal	HEX5	25mm	1
	Hexagonal	HEX6	25mm	1
	Socket adaptor	socket adaptor 1/4"	25mm	1
	Quick release bit holder	KM653-QR*1	60mm	1

59S/31

# STANDARD SCREWDRIVER BIT SET AND BIT HOLDER - 31 PCS



## FEATURES:

- 31 pcs bits set: 30 bits and 1 magnetic quick-release bit holder
- In cardboard packaging
- Drive: 1/4" DIN 3126-C6.3, ISO 1173
- Finish: Zinc phosphate
- Material: High-performance alloy steel

## ASSORTMENT:

Icon	Barcode	Quantity	Icon	Quantity	Quantity	Quantity	Quantity	Quantity
59S/31-1	7314150191451	31	1	110	65	42	250	

Icon	Barcode	Quantity	Icon	Quantity	Quantity	Quantity	Quantity	Quantity
59S/31-2	7314150191468	31	1	110	65	42	250	

Icon	Barcode	Quantity	Icon	Quantity	Quantity	Quantity	Quantity	Quantity
59S/31-3	7314150191475	31	1	110	65	42	245	

## SET CONTAINS:

59S/0.5x3.0, 0.6x4.5, 0.8x5.5 mm		
59S/PH1, 3xPH2, PH3, 2xPH2G		
59S/PZ1, 3xPZ2, PZ3		
59S/T10, 3xT15, 3xT20, 2xT25, T27, T30		
59S/H3.0, 4.0, 5.0, 6.0 mm		
KM-QR 1/4"- 60 mm		

4x59S/PH2, 4xPH2G		
4x59S/PZ2		
2x59S/T10, 4xT15, 5xT20, 5xT25, 2xT30		
KM653-QR 1/4" - 60 mm		

2x59S/PH1, 2xPH2, PH3		
2x59S/PZ1, 2xPZ2, PZ3		
2x59S/TR10, 3xTR15, 5xTR20, 4xTR25, TR27, 4xTR30, TR40		
KM653-QR 1/4" - 60 mm		

59/S54BC

## STANDARD SCREWDRIVER BIT SET, BIT HOLDERS AND 1/4" SOCKET ADAPTOR - 54 PCS



### FEATURES:

- 54 pcs bit set for Slotted, Phillips, Pozidriv, Hexagonal, Robertson and coloured TORX®, TORX® Tamper, head screws
- Drive: 1/4" DIN 3126-C6.3, ISO 1173

- Finish: Sand blasting
- Material: S2 high-alloy steel
- TORX bits are coloured to easily identify by the size of the tip
- -IP: Supplied in a carton display of 8 pcs

### ASSORTMENT:

59/S54BC	7314150337613	54	1	50	184	110	806
59/S54BC-IP	7314150337620	54	1	280	300	190	6168

### SET CONTAINS:

	Slotted	4.5	25mm	1
	Slotted	5.5	25mm	1
	Phillips	PH1	25mm	1
	Phillips	PH2	25mm	4
	Phillips	PH3	25mm	1
	Grabber Phillips	PH2G	25mm	2
	Pozidriv	PZ1	25mm	1
	Pozidriv	PZ2	25mm	4
	Pozidriv	PZ3	25mm	1
	● TORX	T10	25mm	2
	● TORX	T15	25mm	2
	● TORX	T20	25mm	4
	● TORX	T25	25mm	2
	● TORX	T27	25mm	1
	● TORX	T30	25mm	4
	● TORX	T40	25mm	1
	● TORX TAMPER	TR10	25mm	1
	● TORX TAMPER	TR15	25mm	1
	● TORX TAMPER	TR20	25mm	1
	● TORX TAMPER	TR25	25mm	1
	● TORX TAMPER	TR30	25mm	1
	Hexagonal	HEX3	25mm	1
	Hexagonal	HEX4	25mm	1
	Hexagonal	HEX5	25mm	1
	Hexagonal	HEX6	25mm	1
	Hexagonal	HEX8	25mm	1
	Robertson	R1	25mm	1
	Robertson	R2	25mm	1
	Socket adaptor	1/4"	25mm	1
	Phillips	PH1	125mm	1
	Phillips	PH2	125mm	1
	Pozidriv	PZ1	125mm	1
	Pozidriv	PZ2	125mm	1
	TORX	T20	150mm	1
	TORX	T25	150mm	1
	TORX	T30	150mm	1
	Quick release bit holder"	KM653-QR	60mm	1
	Magnetic universal bit holder	KM653	60mm	1

59/S100BC

## STANDARD SCREWDRIVER BIT SET, BIT HOLDERS AND 1/4" SOCKET ADAPTOR - 100 PCS



### FEATURES:

- 100 pcs bit set for Slotted, Phillips, Pozidriv, Hexagon, Robertson and coloured TORX®, TORX® Tamper, head screws
- Drive: 1/4" DIN 3126-C6.3; ISO 1173

- Finish: Sand blasting
- Material: S2 high-alloy steel
- TORX bits are coloured
- -IP: Supplied in a carton display of 8 pcs

### ASSORTMENT:

Part No.	Barcode	QTY	Box	Carton	Carton	Carton	Carton
59/S100BC	7314150337637	100	1	184	110	50	857
59/S100BC-IP	7314150337644	100	1	280	190	300	6590

### SET CONTAINS:

	Slotted	4.5	25mm	1
	Slotted	5.5	25mm	1
	Phillips	PH1	25mm	2
	Phillips	PH2	25mm	9
	Phillips	PH3	25mm	1
	Grabber Phillips	PH2G	25mm	5
	Pozidriv	PZ1	25mm	2
	Pozidriv	PZ2	25mm	9
	Pozidriv	PZ3	25mm	1
	● TORX	T10	25mm	3
	● TORX	T15	25mm	5
	● TORX	T20	25mm	15
	● TORX	T25	25mm	8
	● TORX	T27	25mm	1
	● TORX	T30	25mm	15
	● TORX	T40	25mm	3
	● TORX TAMPER	TR10	25mm	1
	● TORX TAMPER	TR15	25mm	1
	● TORX TAMPER	TR20	25mm	1
	● TORX TAMPER	TR25	25mm	1
	● TORX TAMPER	TR30	25mm	1
	Hexagonal	HEX3	25mm	1
	Hexagonal	HEX4	25mm	3
	Hexagonal	HEX5	25mm	1
	Hexagonal	HEX6	25mm	3
	Hexagonal	HEX8	25mm	1
	Robertson	R1	25mm	1
	Robertson	R2	25mm	1
	Socket adaptor	socket adaptor 1/4"	25mm	1
	Quick release bit holder	KM653-QR	60mm	1
	Magnetic universal bit holder	KM653	60mm	1

# SCREWDRIVER BIT HOLDERS, POWER NUT DRIVERS AND ADAPTORS

50 PRODUCTS

**BAHCO SCREWDRIVER BIT  
HOLDERS: FAST AND SAFE**



QUICK-RELEASE CHUCK FOR  
FAST CONNECTING AND  
CHANGING SCREWDRIVER BITS



LOCK-IN SYSTEM TO  
SECURE THE  
SCREWDRIVER BIT

PERMANENT MAGNET  
FOR QUICK SCREWDRIVER  
BIT ATTACHMENT



## SCREWDRIVER BIT HOLDERS

### KM653-QR

#### MAGNETIC SCREWDRIVER BIT HOLDER WITH QUICK- RELEASE SYSTEM



#### FEATURES:

- Drive: DIN 3126-E6.3, ISO1173
- Material: High-performance alloy steel
- For bits according to DIN 3126, ISO 1173, style C 6.3
- With permanent magnet
- KM653-QR, in plastic box of 5 pcs
- KM653-QR-1P, in plastic holder by unit

#### ASSORTMENT:

KM653-QR-1P	7314151848507	1	1	1/4"	1/4"	60	14	40
KM653-QR	7314150115983	5	1	1/4"	1/4"	60	14	120
KM753-QR-1P	7314150204830	1	1	1/4"	1/4"	75	15	30

### KM100-SH

#### MAGNETIC SCREWDRIVER BIT & SCREW UNIVERSAL HOLDER 1/4" - 75 MM



#### FEATURES:

- Drive: 1/4" DIN 3126-E 6,3, ISO 1173
- Finish: Black finish
- Material: High-performance alloy steel
- With retaining ring
- With strong magnet to hold the screw
- For bits according to DIN 3126, ISO 1173, style C 6.3
- In plastic holder by unit

#### ASSORTMENT:

KM100-SH	7314150215690	1	1	1/4"	1/4"	75	15	35

**KR653****SCREWDRIVER BIT  
UNIVERSAL HOLDER WITH  
RETAINING RING 1/4" - 60 MM****FEATURES:**

- Drive: 1/4" DIN 3126-E 6,3, ISO 1173
- Finish: Black finish
- Material: High-performance alloy steel
- With retaining ring, non-magnetic
- For bits according to DIN 3126, ISO 1173, style C 6.3
- In plastic box: 5 pcs

**ASSORTMENT:**

KR653-1P		7314150260263	1	1	1/4"	1/4"	60	34
KR653		7314150204885	5	1	1/4"	1/4"	60	120

**MAGNETIC:**

KM653-1P		7314151840709	1	1	1/4"	1/4"	60	10	32
KM653		7314151786915	5	1	1/4"	1/4"	60	10	120

**KM653-SF****SCREWDRIVER BIT UNIVERSAL  
HOLDER WITH SWIVELLING  
FUNCTION 1/4" - 60 MM****FEATURES:**

- Drive: DIN 3126-E6.3, ISO1173
- Material: High-performance alloy steel
- For bits according to DIN 3126, ISO 1173, style C 6.3
- With permanent magnet and with swivel function providing mobility to reach tight spots
- In plastic holder by unit

**ASSORTMENT:**

KM653-SF		7314150204984	1	1	1/4"	1/4"	60	14	45

**KMR653****MAGNETIC SCREWDRIVER BIT  
UNIVERSAL HOLDER WITH  
RETAINING RING 1/4" - 60 MM****FEATURES:**

- Drive: 1/4" DIN 3126-E 6,3, ISO 1173
- Finish: Black finish
- Material: High-performance alloy steel
- With strong magnet and retaining ring
- For bits according to DIN 3126, ISO 1173, style C 6.3
- KMR653, in plastic box of 5 pcs
- KMR653-1P, in plastic holder

**ASSORTMENT:**

KMR653-1P	7314150204939	1	1	1/4"	1/4"	60	11	35	
KMR653	7314150204922	5	1	1/4"	1/4"	60	11	120	
KMR753-1P	7314150204953	1	1	1/4"	1/4"	60	11	45	
KMR753	7314150204946	5	1	1/4"	1/4"	60	11	180	

**KSR753****STAINLESS STEEL SCREWDRIVER BIT  
UNIVERSAL HOLDER WITH  
RETAINING RING 1/4" - 75 MM****FEATURES:**

- Drive: 1/4" DIN 3126-E 6,3, ISO 1173
- Finish: Stainless steel
- Material: High-performance stainless steel
- With retaining ring. Non-magnetic
- For bits according to DIN 3126, ISO 1173, style C 6.3
- Application: Non-rusting stainless steel, suitable to use with stainless steel bits
- KSR753, in plastic box of 5 pcs
- KSR753-1P, in plastic holder by unit

**ASSORTMENT:**

KSR753-1P	7314150204908	1	1	1/4"	1/4"	75	50		
KSR753	7314150204892	5	1	1/4"	1/4"	75	210		

**KM1/4-5/16-1P****MAGNETIC SCREWDRIVER  
BIT UNIVERSAL  
HOLDER 1/4" - 70 MM****FEATURES:**

- Drive: 5/16" DIN 3126-E8, ISO 1173
- Finish: Black finish
- Material: High-performance alloy steel
- With strong magnet
- In plastic holder (1 pc)

**ASSORTMENT:**

KM1/4-5/16-1P	7314150275953	1	1	5/16"	1/4"	70	45		

**KCB753****COPPER-BERYLLIUM SCREWDRIVER  
BIT UNIVERSAL HOLDER WITH  
RETAINING RING 1/4" - 75 MM****FEATURES:**

- Drive: 1/4" DIN 3126-E 6,3, ISO 1173
- Finish: Copper-Beryllium (sleeve)
- Material: High-performance alloy steel
- With retaining ring, non-magnetic
- For bits according to DIN 3126, ISO 1173, style C 6.3
- Application: Suitable for applications that require a very high torque or peak loads
- High wear and corrosion resistance
- In plastic holder by unit

**ASSORTMENT:**

KCB753	7314150204915	1	1	1/4"	1/4"	75	50		



**KMR150****MAGNETIC SCREWDRIVER BIT  
UNIVERSAL HOLDER 1/4" - 150 MM****FEATURES:**

- Drive: 1/4" DIN 3126-E 6,3, ISO 1173
- Finish: Black finish
- Material: High-performance alloy steel
- With strong magnet and retaining ring
- For bits according to DIN 3126, ISO 1173, style C 6.3
- KMR150, in plastic box of 5 pcs
- KMR150-1P, in plastic holder by unit

**ASSORTMENT:**

KMR150-1P	7314150204977	1	1	1/4"	1/4"	150	11	70
KMR150	7314150204960	5	1	1/4"	1/4"	150	11	285

**POWER NUT DRIVERS****K6750****POWER NUT DRIVER - 50 MM****FEATURES:**

- Drive: 1/4"DIN 3126 E6.3, ISO1173
- Finish: Black finish
- Material: High-performance alloy steel

- Hexagon socket
- In a plastic box containing one nut driver

**ASSORTMENT:**

K6750-6	7314150204670	1	1	6	1/4"	50	11,5	25
K6750-7	7314150204687	1	1	7	1/4"	50	12	28
K6750-8	7314150204694	1	1	8	1/4"	50	12,5	36
K6750-10	7314150204700	1	1	10	1/4"	50	14,5	36
K6750-13	7314150204823	1	1	13	1/4"	50	17	40
K6750-1/4	7314150204663	1	1	1/4"	1/4"	50	10,5	22
K6750-3/8	7314150204656	1	1	1/4"	3/8"	50	14,4	35

**MAGNETIC:**

KM6750-6	7314150204601	1	1	6	1/4"	50	11,5	25
KM6750-7	7314150204618	1	1	7	1/4"	50	12	28
KM6750-8	7314150204625	1	1	8	1/4"	50	12,5	31
KM6750-10	7314150204649	1	1	10	1/4"	50	14,5	36
KM6750-11	7314150302628	1	1	11	1/4"	50	16	38
KM6750-13	7314150204632	1	1	13	1/4"	50	17	40
KM6750-1/4	7314150204595	1	1	1/4"	1/4"	50	10,5	22
KM6750-3/8	7314150204588	1	1	3/8"	1/4"	50	14,4	35

# ADAPTORS

## K6625

### SOCKET ADAPTOR WITH HEX 1/4" FOR SQUARE 1/4" - 25 MM



#### FEATURES:

- Suitable for DIN 3120, ISO 1174, style A 6.3
- Finish: Black finish
- Material: High-performance alloy steel
- Male hexagon to male square 1/4" DIN 3120-A6,3
- Ball type
- In plastic box of 5 pcs

#### ASSORTMENT:

Part No.	Barcode	Box	Unit	Hex	Square	Length	Weight
K6625-1/4-1P	7314150260140	1	1	1/4"	1/4"	25	13
K6625-1/4	7314150204496	5	1	1/4"	1/4"	25	54

## K6638

### SOCKET ADAPTOR WITH HEX 1/4" FOR SQUARE 3/8" - 38 MM



#### FEATURES:

- Suitable for DIN 3120, ISO 1174, style A 10
- Finish: Black finish
- Material: High-performance alloy steel
- Hexagon male to square male 3/8" DIN 3120-A10
- Ball type
- In plastic box of 5 pcs

#### ASSORTMENT:

Part No.	Barcode	Box	Unit	Hex	Square	Length	Weight
K6638-3/8-1P	7314150260164	1	1	3/8"	1/4"	38	31
K6638-3/8	7314150204557	5	1	3/8"	1/4"	38	129

## K6650

### SOCKET ADAPTOR WITH HEX 1/4" FOR SQUARE 1/4" OR 3/8" - 50 MM



#### FEATURES:

- Suitable for DIN 3120, ISO 1174, style F 6.3, F 10, F 12,7
- Length adaptor: 50mm
- Finish: Black finish
- Material: High-performance alloy steel
- Hexagon male to square male DIN 3120
- Pin type (except K6650-1/4-1P ball type)
- In plastic box of 5 pcs (except K6650-1/4-1P packed by unit)

#### ASSORTMENT:

Part No.	Barcode	Box	Unit	Hex	Square	Length	Weight
K6650-1/4-1P	7314150204533	1	1	1/4"	1/4"	50	25
K6650-1/4	7314150204526	5	1	1/4"	1/4"	50	90
K6650-3/8-1P	7314150260225	1	1	3/8"	1/4"	50	30
K6650-3/8	7314150204502	5	1	3/8"	1/4"	50	135
K6650-1/2-1P	7314150260188	1	1	1/2"	1/4"	50	42
K6650-1/2	7314150204519	5	1	1/2"	1/4"	50	180

## K66100

### SOCKET ADAPTOR WITH HEX 1/4" FOR SQUARE 1/4" OR 3/8" - 100 MM



#### FEATURES:

- Suitable for DIN 3120, ISO 1174, style F 6.3 and F 10
- Finish: Black finish
- Material: High performance alloy steel
- Hexagon male to square male DIN 3120
- K66100-1/4: Pin type
- K66100-3/8: Ball type
- In plastic box of 5 pcs

#### ASSORTMENT:

Part No.	Barcode	Box	Unit	Hex	Square	Length	Weight
K66100-1/4-1P	7314150260201	1	1	1/4"	1/4"	100	46
K66100-1/4	7314150204540	5	1	1/4"	1/4"	100	190
K66100-3/8-1P	7314150260249	1	1	3/8"	1/4"	100	58
K66100-3/8	7314150204564	5	1	3/8"	1/4"	100	190

**K6660-QR**

## **SOCKET ADAPTOR WITH HEX 1/4" FOR SQUARE 1/4" - 60 MM**



### **FEATURES:**

- Suitable for DIN 3120, ISO 1174
- Finish: Black finish
- Material: High-performance alloy steel
- With quick-release system for easy locking
- Hexagon male to square male DIN 3120
- Ball type
- In plastic holder by unit

### **ASSORTMENT:**

K6660-QR-1P	7314150204571	1	1	1/4"	1/4"	60	30

**54640**

## **BIT ADAPTOR WITH HEX 1/4" FOR SQUARE 5/16" - 40 MM**



### **FEATURES:**

- Spare part for impact screwdrivers, ref. 5521
- 1/2" square drive
- For 5/16" bits
- Bit-retaining ring

### **ASSORTMENT:**

54640	7314150215720	1	1	5/16"	1/2"	40	54



# **FULL SERVICE**

*POWER*

**Bahco adds even more power to the range of quality products by providing full knowledge sharing. This ensures that you always find the right accessory. Because using them for the right type of application truly puts the POWER into these Power Tool Accessories.**

**Full service is shaped through:**

**THE BAHCO ACADEMY**

To expand and maintain the extensive knowledge and experience with the Power Tool Accessories programme, we have our own academy with training centres across Europe. In our training centres in the UK, Sweden, Italy, Poland, Belarus and Turkey, colleagues, customers and end users share the product specifications, techniques, problem-solving and how to get the maximum out of every tool.

**FULL IN-STORE SUPPORT**

Thanks to our new in-store communication programme, you will quickly find the right product in your local shop.



# ICON OVERVIEW

## HOLESAWS



**PRODUCT  
CODE**



**EAN  
CODE**



**PACK  
QUANTITY**



**BOX  
QUANTITY**



**HOLESAW  
LENGTH**



**HOLESAW  
DIAMETER**



**SMALL  
ARBOR**



**BIG  
ARBOR**



**TYPE OF  
PILOT DRILL**



**SHANK  
WIDTH**



**CHUCK  
WIDTH**

**A B**

**SIZE  
A, B, ... (MM)**



**ADD-ON**



**WEIGHT**

## SABRE SAW BLADES



**PRODUCT  
CODE**



**EAN  
CODE**



**PACK  
QUANTITY**



**BOX  
QUANTITY**



**SAW BLADE  
LENGTH**



**SAW BLADE  
WIDTH**



**TPI:  
TEETH PER INCH**



**TYPE OF  
SAW BLADE**

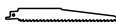

**SAW BLADES  
IN SET**



**WEIGHT**

## JIGSAW BLADES



**PRODUCT  
CODE**



**EAN  
CODE**



**PACK  
QUANTITY**



**BOX  
QUANTITY**



**TYPE OF  
TOOTHING**



**MATERIAL**



**TPI:  
TEETH PER INCH**

**A B**

**SIZE  
A, B, ... (MM)**



**WEIGHT**

## CIRCULAR SAW BLADES



PRODUCT  
CODE



EAN  
CODE



PACK  
QUANTITY



BOX  
QUANTITY

A B

SIZE  
A, B, ... (MM)



WEIGHT

## PORTABLE BAND SAW BLADES



PRODUCT  
CODE



EAN  
CODE



PACK  
QUANTITY



BOX  
QUANTITY



SAW BLADE  
HEIGHT



SAW BLADE  
WIDTH



TPI:  
TEETH PER INCH



TYPE OF  
SAW BLADE



LOOP  
LENGTH



WEIGHT

## ROTARY BURRS



PRODUCT  
CODE



EAN  
CODE



PACK  
QUANTITY



BOX  
QUANTITY



TYPE  
OF TOOTHING



NUMBER  
OF TEETH



STOCK

A B

SIZE  
A, B, ... (MM)



WEIGHT

## DRILL BITS



PRODUCT  
CODE



EAN  
CODE



PACK  
QUANTITY



BOX  
QUANTITY

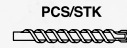

PIECES  
PER SET

A B

SIZE  
A, B, ... (MM)



WEIGHT

## SCREWDRIVER BITS



PRODUCT  
CODE



EAN  
CODE



PACK  
QUANTITY



BOX  
QUANTITY



TYPE  
OF HEAD



TIP  
THICKNESS



TIP  
WIDTH



SCREWDRIVER  
BIT LENGTH



BOX LENGTH



BOX  
WIDTH



BOX  
HEIGHT



SCREWDRIVER  
BIT DIAMETER



WEIGHT



**BAHCO**

[www.bahco.com](http://www.bahco.com)

PTA-ENG-19



7 314 150 428076